

Symbolische Darstellung
Symbolic Illustration

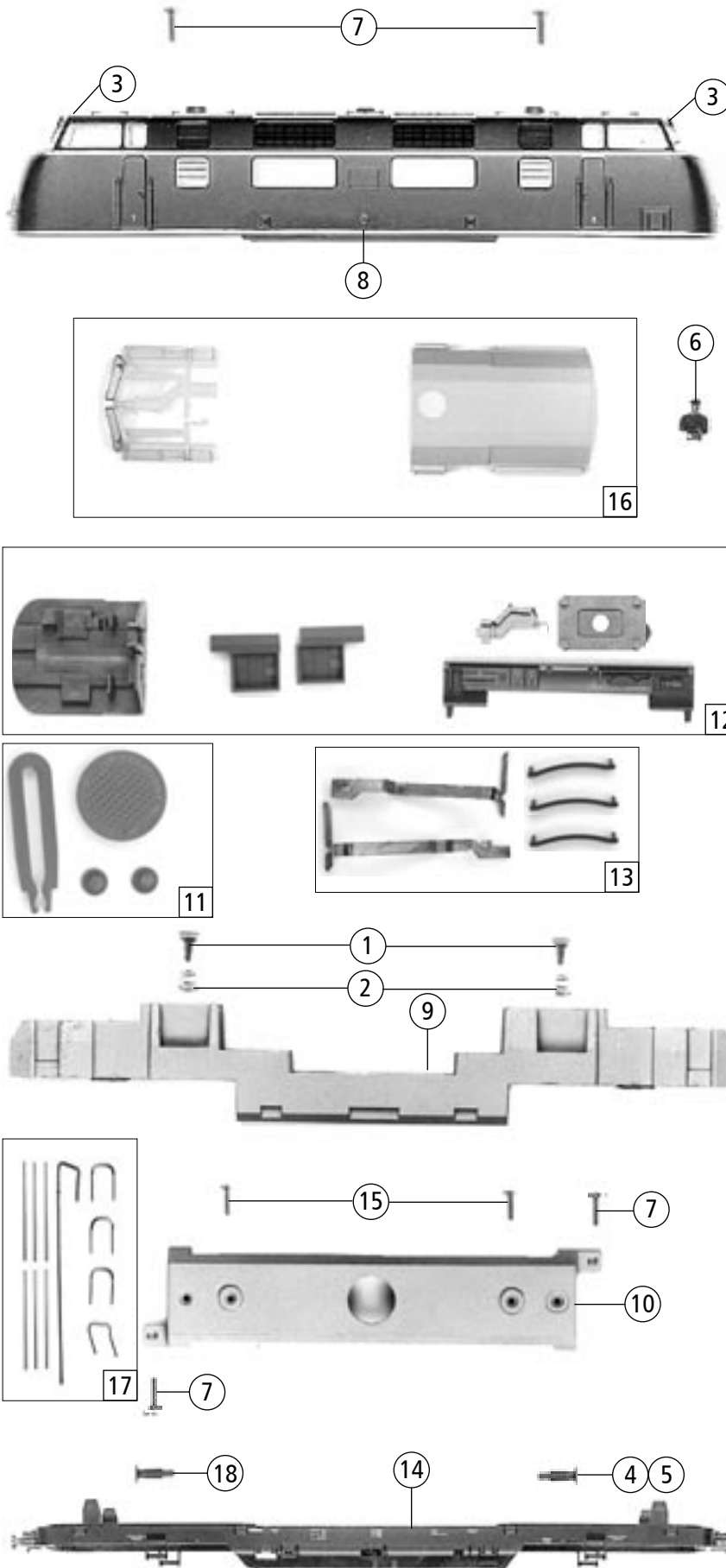

Pos. Nr. Pos.no.	Beschreibung Description	Art.-Nr. Art.no.	Preisgruppe Price bracket
63932	DB 220 =		
63933	DB 220 =		
69933	~		
1	FK-Schraube M 2 x 2,8 Screw M 2 x 2.8	85704	3
2	Feder Spring	86229	2
3	Lokpfeife Lokomotive pipe	88002	6
4	Puffer gewölbt rechts Buffer vaulted right	98859	4
5	Puffer flach links Buffer flat left	98860	4
6	E-Lokführer Engine driver	89732	5
7	Schraube M 2 x 6 Screw M 2 x 6	114828	2
8	Gehäuse lackiert und bedruckt Betr. Nr. 220 001-2 Body printed and coated Loco no. 220 001-2	116489	65
9	Grundrahmen (Zinkal) Loco base (Zincal)	115196	28
10	Gewicht Weight	115197	22
11	Teilesatz Parts set	115198	6
12	Inneneinrichtungssatz Interior set	115806	10
13	Lichtleitstabsatz Light transmission bar set	115200	7
14	Lokrahmen Loco frame	116487	28
15	Schraube M 2 x 5 Screw M 2 x 5	115205	2
16	Fenstersatz Window set	115207	10
17	Griffstangensatz Handle bar set	115208	8
18	Elastikpuffer Elastic buffer	115209	2

Änderungen in Konstruktion und Ausführung vorbehalten
We reserve the right to change the construction and specification

Symbolische Darstellung
Symbolic Illustration

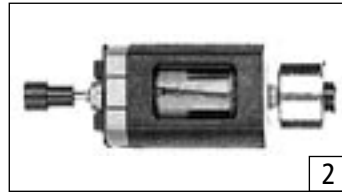
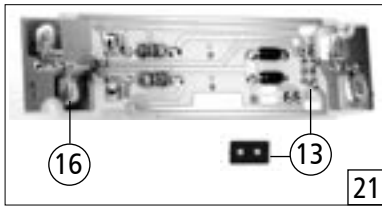

20 o. Abb. / no ill.
Decoderdeckel
Decoder cap

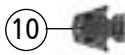
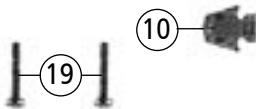
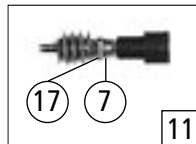
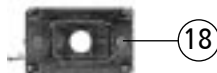
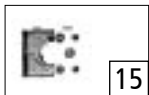

24

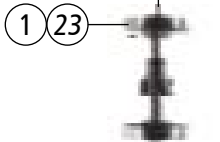
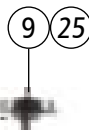
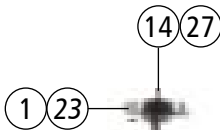
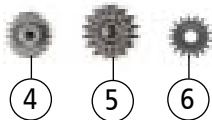
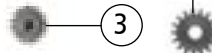

Pos. Nr. Pos.no.	Beschreibung Description	Art.-Nr. Art.no.	Preisgruppe Price bracket
63932	220 =		
63933	220 =		
69933			
1	Hafringsatz 10 Stk.10,3-12,8mm Set with traction tires	40069	---
2	Motor Motor	85114	57
3	Zahnrad Z=17 Gear Z=17	86409	2
4	Zahnrad Z=12/M=0.4 Gear Z=12/M=0.4	86412	2
5	Zahnrad Z=21 G/M=0.4 Gear Z=21 G/M=0.4	86414	2
6	Schneckenrad doppelt Worm gear double86419	86419	4
7	Lager für Schneckenachse Worm axle bearing	89749	6
8	Radkontakt Wheelcontact	89805	3
9	Radsatz mit Zahnrad Wheelset with gear	90026	16
10	Kupplungshalter Coupling holder	95176	2
11	Schneckensatz Worm set	97753	24
12	Antriebssatz Drive set	97756	14
13	Brückenstecker Bridge Connector	100644	7
14	Radsatz mit Hafringen Wheelset with traction tires	107074	20
15	Schneckendeckel mit Stabilisatorfeder Worm cover	107201	8
16	Drahtlampe 16 V Light bulb 16 V	109321	10
17	Scheibe Washer	112681	2
18	Distanzplättchen Spacer	113326	3
19	GF-Schraube M 2 x 10 Screw M 2 x 10	114854	2
20	Decoderdeckel o. Abb. Decoder cap	115024	20
21	Platine komplett Printed circuit assembly	115203	43
~ Wechselstrom AC			
22	Flüsterschleifer, kurz Whisper wiper, short	40064	---
23	Hafringsatz 10 Stk.10,3-12,4mm Set with traction tires	40074	---
24	Zahnrad z=17; m 0,4 (o. Abb.) Gear T=17; m 0,4 (no ill.)	86418	2
25	Radsatz mit Zahnrad Wheelset with gear	90802	16
26	Radsatz ohne Zahnrad Wheelset without gear	90804	14
27	Radsatz mit Zahnrad und Hafringen Wheelset with gear and traction tires	107336	20
28	GF-Schraube M 1,6 x 10 Screw M 1,6 x 10	114881	2

7 o. Abb. / no ill.
Isolierung
Insulating

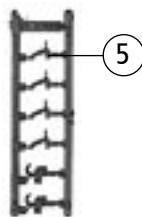
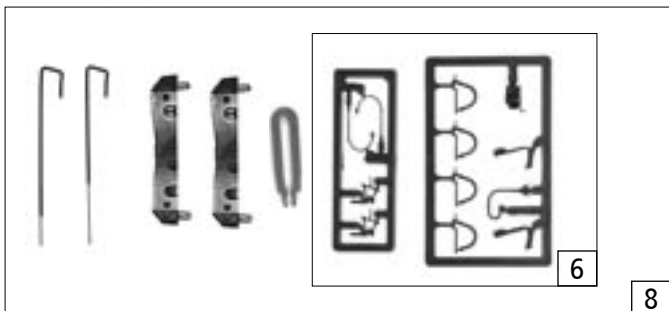
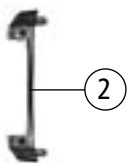
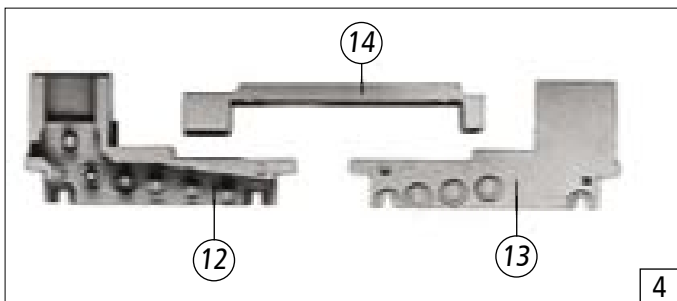
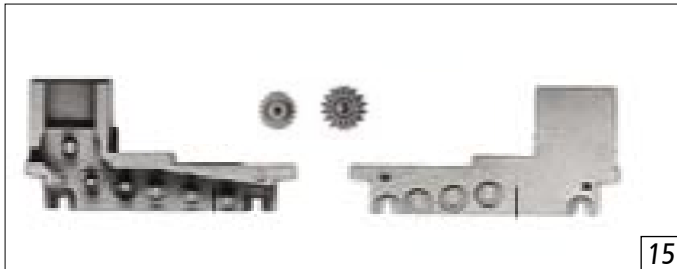
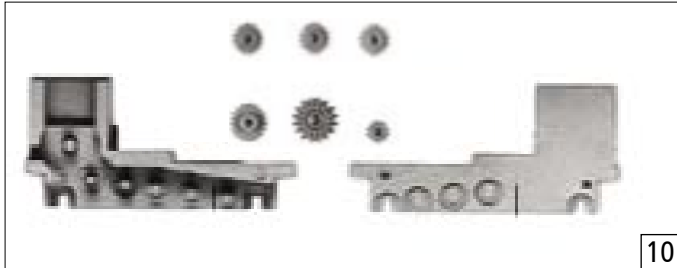
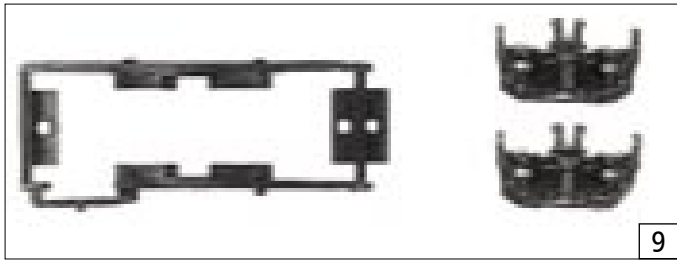

Pos. Nr. Pos. no.	Beschreibung Description	Art.-Nr. Art. no.	Preisgruppe Price bracket
63932	DB 220 =		
63933	DB 220 =		
69933	~		
1	Universalkupplung Universal coupling	89282	5
2	Schürze offen Steamlining open	95175	2
3	Kupplungshalter Coupling holder	95176	2
4	Getriebesatz komplett Gear part assembly	97746	20
5	Atrappenrahmen klein Push in part set,small	107808	3
6	Teilesatz Parts set	108322	8
7	Isolierung o. Abb. Insulating	115202	2
8	Zurüstbeutel Bag with accessories	116488	15
9	Blendensatz komplett Bogie set assembly	115421	14
10	Getriebe komplett Gear assembly	116490	23
~ Wechselstrom AC			
11	Isolierteil Insulating	91619	2
12	Getriebekasten Gear box	95280	25
13	Getriebedeckel Gear cover	95281	10
14	Getriebeboden Gear bottom	95282	16
15	Getriebe komplett Gear assembly	116491	23

Ersatzteile erhalten Sie bei Ihrem Fachhändler,
oder Ihrer Landesvertretung oder bei:

You can order your Replacement Parts at your
local dealer, your country representative or:

Roco Modellspielwaren GmbH
Kundendienst
Rifer Hauptstraße 21
A-5400 Hallein

