

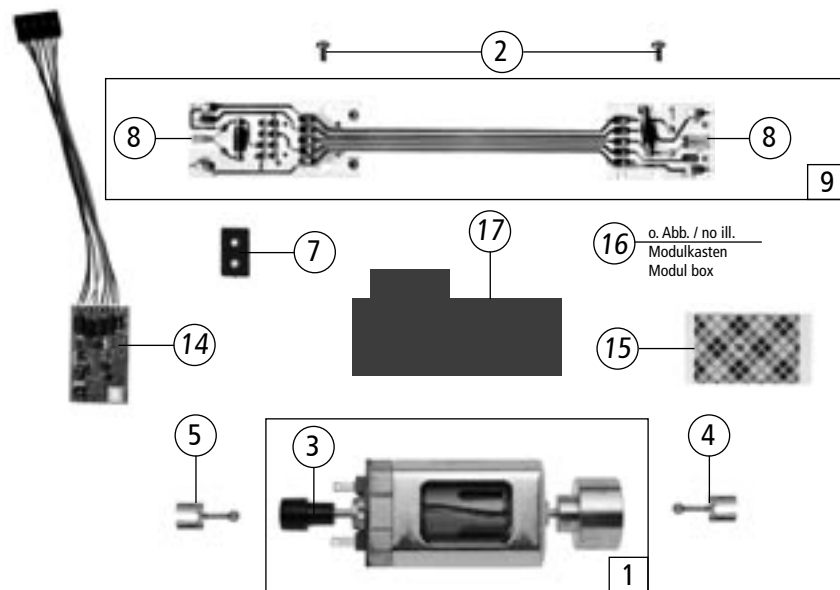

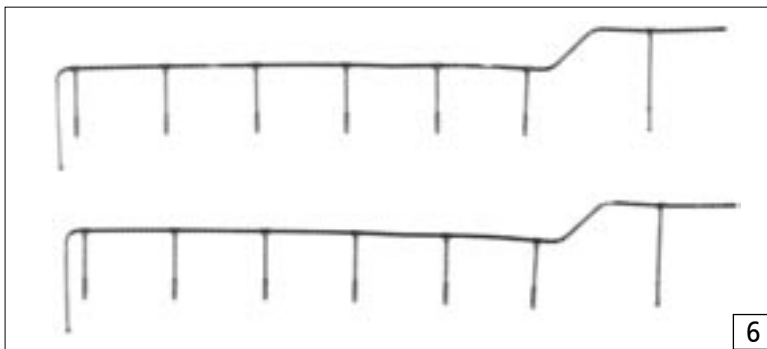

Symbolische Darstellung
Symbolic Illustration

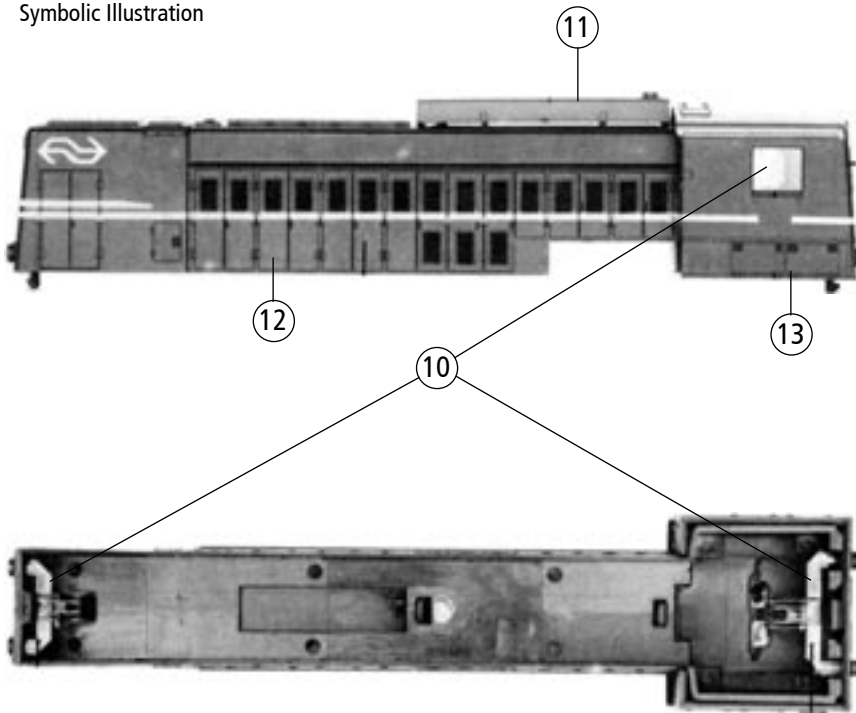

Pos. Nr. Pos.no.	Beschreibung Description	Art.-Nr. Art.no.	Preisgruppe Price bracket
63927	 2200	=	
69927		~	
1	Motor Motor	85060	57
2	Schraube M 2X5 Schroef M 2x5	85671	2
3	Kardanschale kurz Cardan shaft,short	87129	3
4	Gelenkwelle Cardanas	87138	3
5	Gelenkwelle L-12.5 Cardanas L=12,5	87174	4
6	Geländersatz Rail set	92901	16
7	Brückenstecker Connector	100644	7
8	Drahtlampe T3/4 16V 30mA Conductor lamp T3/4 16V 30mA	108616	10
9	Platine kpl. Printed circuit assembly	112817	43
10	Teilesatz Part est	112823	15
11	Auspuffkasten Exhaust pipe box	112824	2
12	Gehäuse lackiert und bedruckt Betr.Nr. 2225 Body coated and printed Loco no. 2225	116790	39
13	Führerhaus lackiert und bedruckt Drivers cab coated and printed	116791	37
~ Wechselstrom AC			
14	Decoder Motorola Motorola Formaat decoder	10738	---
15	Doppelseitiges Klebeband Adhesive tape	112629	2
16	Modulkasten Modul box	112825	4
17	Isolierung Insulating	116095	2

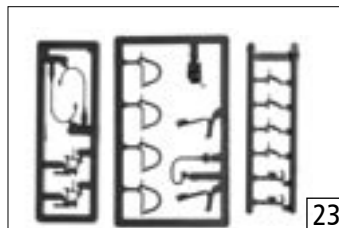
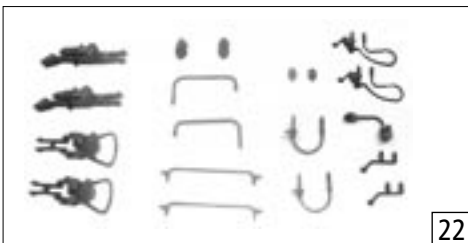
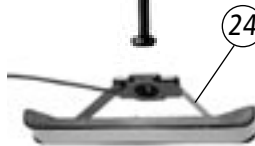
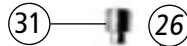
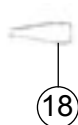
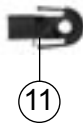
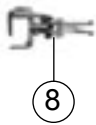
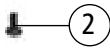
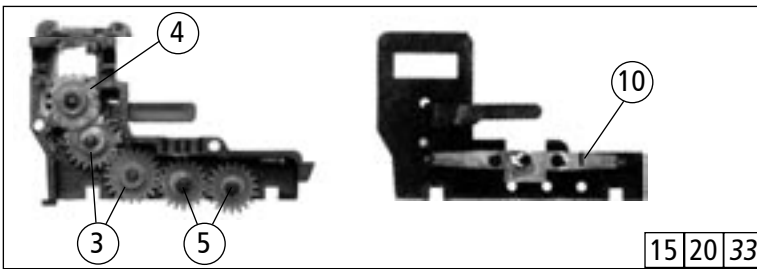
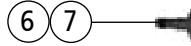
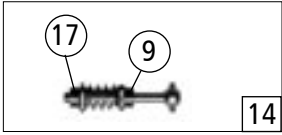
Änderungen in Konstruktion und Ausführung vorbehalten
We reserve the right to change the construction and specification



Pos. Nr. Pos.no.	Beschreibung Description	Art.-Nr. Art.no.	Preisgruppe Price bracket
63927	 2200	=	
69927			
1	Haftringsatz DC Traction tyres set	40069	--
2	Schraube M 2,2x9,5 Screw M 2,2x9,5	85808	2
3	Zahnrad Gear	86414	2
4	Schnecken Zahnrad Worm gear	86490	4
5	Zahnrad Gear	86493	2
6	Puffer flach Buffer flat	88600	3
7	Puffer gewölbt Buffer vaulty	88601	3
8	Universalkupplung Universal coupling	89282	5
9	Lager für Schneckenachse Ex store vor worm axle	89749	6
10	Radkontakt Weel contact	89804	2
11	Kupplungskammer Couplings holder	115069	3
12	Radsatz ohne Einstich Weelset zonder insteek	111124	18
13	Radsatz mit 2 Haftringen Weelset with 2 traction tyre	111125	20
14	Schneckensatz Worm set	111307	24
15	Teilesatz Getriebekasten und Getriebedeckel Part set gear box and gear cap	112820	12
16	Teilesatz Part set	112821	12
17	Anlaufschibe 4x2,1x0,1 Washer disc 4x2,1x0,1	113942	2
18	Stellfeder Spring	114872	2
19	Kammerdeckel Chamber cap	115070	3
20	Getriebe komplett Gear assembly	116786	20
21	Unterteil Chassis	116787	20
22	Zurüstbeutel Bag with accessories	116788	20
23	Teilesatz Part set	116789	8
Wechselstrom AC			
24	AC-Flüsterschleifer kurz Whisper wiper, short	40064	---
25	Haftringsatz AC Traction tyre set AC	40074	---
26	Schraube M 1,6x5 Screw M 1,6x5	85702	2
27	Radsatz ohne Zahnrad Weelset without gear	110520	16
28	Radsatz mit 2 Haftringen Weelset with 2 traction tyre	111109	20
29	Radsatz o. Haftring Weelset without traction tyre	111110	18
30	Zahnrad Z=14 Gaer Z=14	111115	2
31	Anschlussnippel Connection nipple	111116	3
32	Blende AC Bogie AC	112826	20
33	Teilesatz Getriebekasten und Getriebedeckel Part set gear box and gear cap	112827	12

Ersatzteile erhalten Sie bei Ihrem Fachhändler, oder Ihrer Landesvertretung oder bei:

You can order your Replacement Parts at your local dealer, your country representative or:

Roco Modellsportwaren GmbH
Kundendienst
Rifer Hauptstraße 21
A-5400 Hallein

