

62318		DB	BR 41	=	
Pos. Nr. Pos.no.	Beschreibung Description	Art.-Nr. Art.no.	Preisgruppe Price bracket		
1	Puffer flach rund Metall Buffer flat round metal	88556	5		
2	Puffer gewölbt rund Metall Buffer vaulted round metal	88557	5		
3	Schaltachse l=92mm Switch rod l=92mm	89945	4		
4	Witte Windleitblech links Witte smoke deflector left	109502	8		
5	Witte Windleitblech rechts Witte smoke deflector right	109503	8		
6	Ölkanne Oil canister	92453	4		
7	Bremsgestänge u. Leitungen Brake leverage a. lines	93904	9		
8	TS-Rauchfang u. Domdeckel Part set chimney a. dome cover	93907	9		
9	TS-Kessel u. Umlauf Part set boiler a. runningboard	93908	9		
10	TS-Kesselleitungen Part set boiler lines	93909	9		
11	TS-Kesselsteckteile Part set boiler push in part	93910	9		
12	TS-Schaltachslager u. Pfeife Part set control rod axle a. whistle	93911	9		
13	Kesseldeckel m. Lampe Boiler cover w. lamp	131353	7		
14	Fenster links Window left	93919	4		
15	Fenster rechts Window right	93920	4		
16	Schaltstange Control rod	93923	4		
17	Kesselaufgabe Boiler support	93924	4		
18	Lokplatinen kpl. m. LED-Platine Loco printed circuit ass. w. LED-printed circuit	126942	27		
19	Laufsteg lack. u. bed. m. Sandkastendeckel Runningboard coat. a. pri. w. sandboxcover	131351	18		
20	Umlaufblecheinsatz Part	126944	7		
21	Federpaket Spring pack	93973	4		
22	Federpaket rechts Spring pack right	126935	4		
23	Auftritt Entrance	93974	3		
24	Indusi Steckteil Push in part induci	93975	5		
25	Führerhaus lack. u. bedruckt Betr.nr: 41 095 Drivers cab coat. a. printed loco no. 41 095	131354	18		
26	Kessel kpl. Betr.nr: 41 095 Boiler ass. loco no. 41 095	131350	39		
27	Leuchtstab vorne u. mitte Light transmission bars	126934	6		
28	Kesselunterteil Boiler bottom	126938	8		
29	Kesselgewicht Boiler weight	126939	8		
30	TS-Inneneinrichtung u. Hebel Part set	126940	6		
31	Seuthehalter Seutheholder	126943	5		

Änderungen in Konstruktion und Ausführung vorbehalten
We reserve the right to change the construction and specification

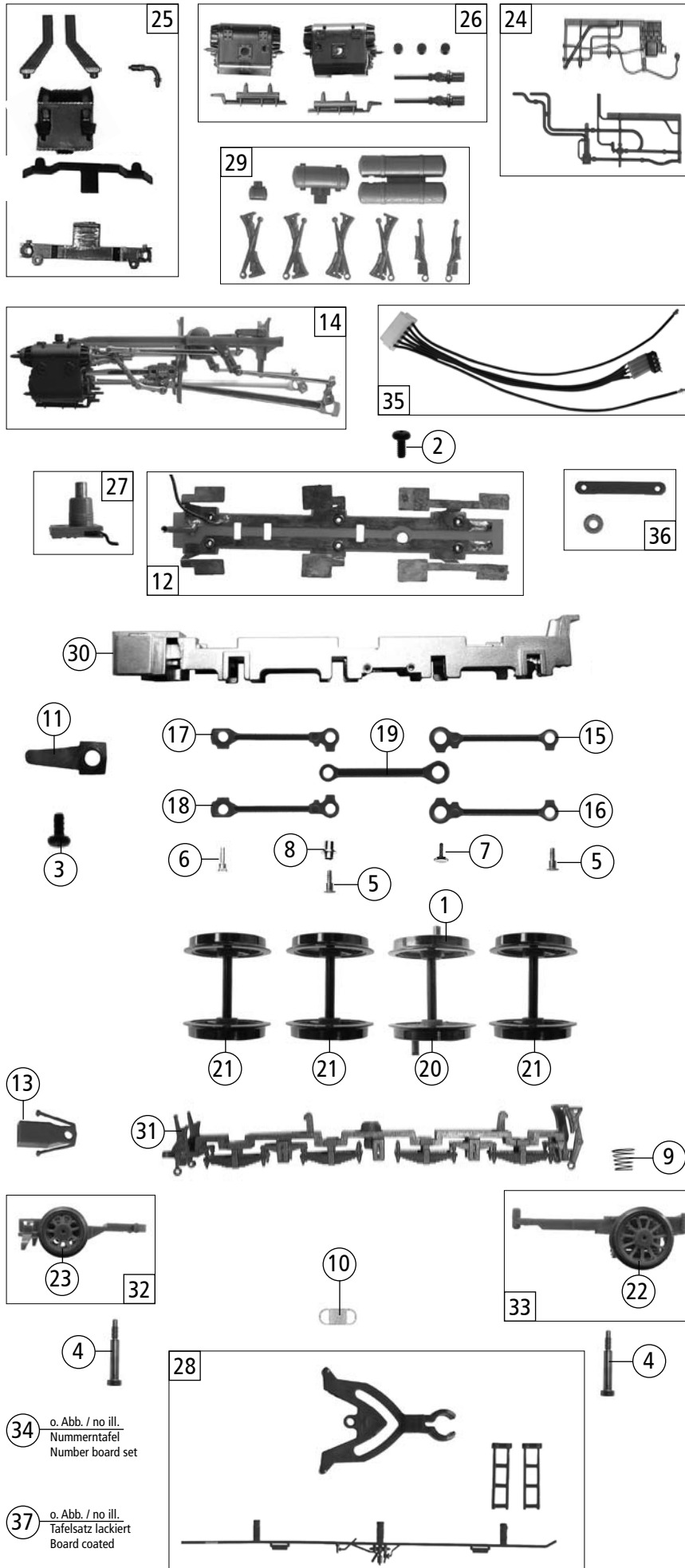

Pos. Nr. Pos.no.	Beschreibung Description	Art.-Nr. Art.no.	Preisgruppe Price bracket
1	Hafringsatz 10Stk. 16,5-19mm Set w. traction tires 10 pieces 16,5-19mm	40072	---
2	Schraube M1,6x3 Screw M1,6x3	85658	3
3	Schraube M2x5 Screw M2x5	85693	3
4	Schraube M2x11 Screw M2x11	85717	5
5	Schraube M1,4x3,2x1,5 büniert Screw M1,4x3,2x1,5 browned	85770	4
6	Schraube M1,4x3,2x1,1 Screw M1,4x3,2x1,1	85764	3
7	Schraube M1x3,6 Screw M1x3,6	85765	3
8	Distanzhülse Distance tube	86104	6
9	Druckfeder Spring	86234	3
10	Zugfeder Spring	86208	3
11	Vorlaugestellfeder Spring	108888	5
12	Lokplatine kpl. Loco printed circuit ass.	126919	19
13	Kupplungskammer Coupling chamber	89272	4
14	Steuerung kpl. Seering ass.	126921	36
15	Kuppelstange rechts hinten Coupling rod right rear	108883	7
16	Kuppelstange links hinten Coupling rod left rear	108884	7
17	Kuppelstange rechts vorne Coupling rod right front	108885	7
18	Kuppelstange links vorne Coupling rod left front	108886	7
19	Kuppelstange mitte links u. rechts Coupling rod middle left a. right	108887	7
20	Radsatz großes Gewicht m. Hafring Wheelset w.bigweight w.traction tires	90545	12
21	Radsatz kleines Gewicht Wheelset w. little weight	90546	12
22	Nachlaufradsatz Wheelset	90547	9
23	Vorlaufradsatz Pilot wheelset	90548	9
24	Steckteile links u. rechts Push in parts left a. right	93905	9
25	TS-Einströmröhre,... Part set	93906	11
26	TS-Zylinderblock, Steuerung Part set cylinder block, steering	93912	9
27	Seuteheinsatz Seuthe element	131346	14
28	TS-Lok-Tenderkupplung, Part set loco a. tender, tender lines	111767	6
29	TS-Bremsbacken,... Part set brake shoe	93976	12
30	Lokgrundrahmen Loco frame	131345	13
31	Deckel Lokgrundrahmen Cover loco frame	93978	11
32	Vorlaugestell kpl. Pilot frame ass	93979	15
33	Nachlaufgestell kpl. Tail bogie ass.	93980	14
34	Nummerntafel Numberboard	131352	6
35	Kabelbaum 6-polig Wiring harness 6-pole	126920	13
36	Kabelspanne u. Isolierscheibe Cabel holder a. insulating washer	126945	8
37	Tafelsatz lackiert Board set coated	131355	12

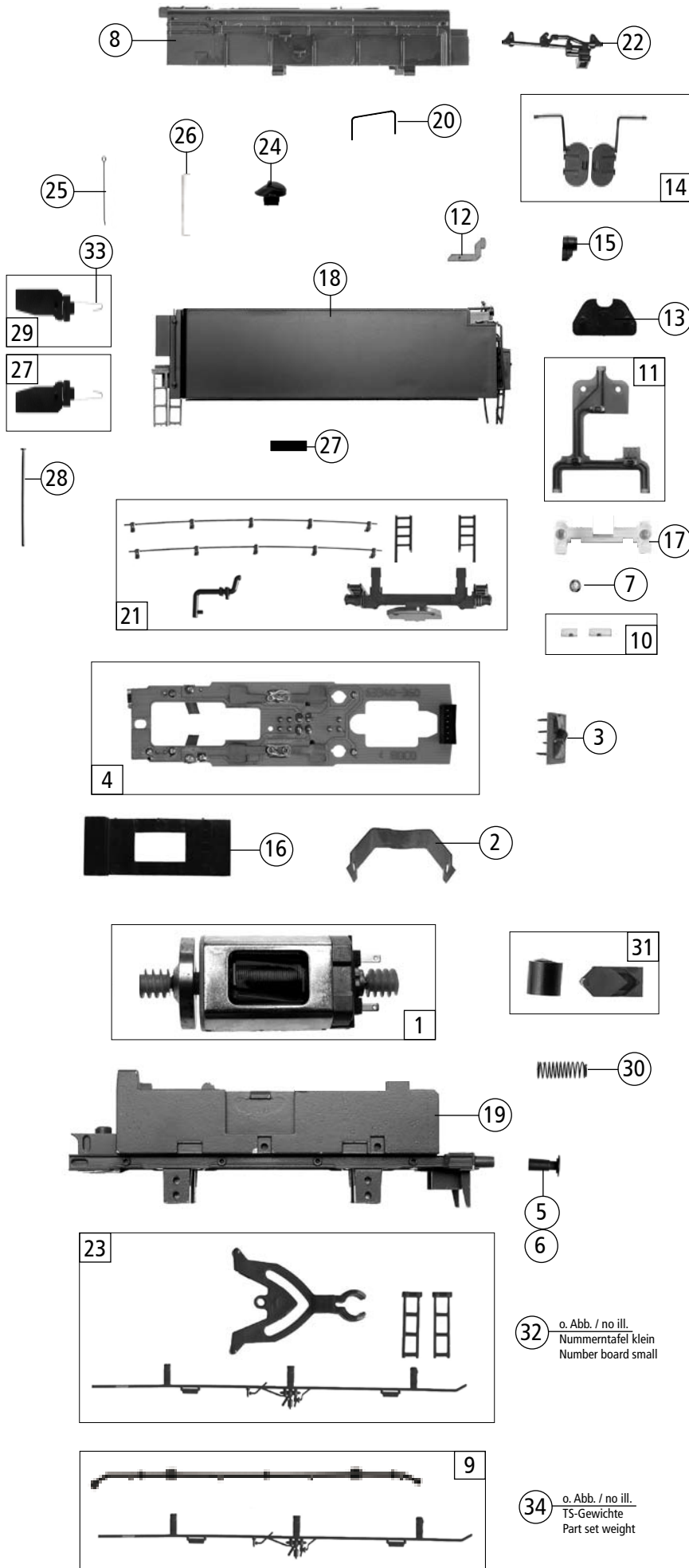

62318		DB	BR 41	=
Pos. Nr. Pos.no.	Beschreibung Description	Art.-Nr. Art.no.	Preisgruppe Price bracket	
1	Motor Motor	126931	28	
2	Motorspange Clip for the motor	121691	5	
3	Brückenstecker m. Kondensator Connector w. capacitor	125666	9	
4	Tenderplatine kpl Tender Printed circuitass.	126930	22	
5	Puffer rund flach Metall Buffer round flat metal	88502	5	
6	Puffer rund gewölbt Metall Buffer round vaulted metal	88503	5	
7	Linse klein Lens small	111891	3	
8	Öltenderaufsatz Oil-tender attachment	126924	8	
9	Tenderleitungssatz Tender pipe set	114666	6	
10	Tenderlichtnagel unten Tendr lens	117430	5	
11	Tenderflex kpl. m. 3LED's Tender flex ass. w. 3LED's	120427	17	
12	Spitzenlichtleiter Öltender Light transmission bar	127181	3	
13	Flexhalter Flex holder	122071	3	
14	Wasserklappe links u. rechts Water fold semtemccce	120293	5	
15	Stirnlampe für Tender Lamp for tender	111804	6	
16	Modulhalter Module holder	111877	3	
17	Tenderlampe Tender lamp	126928	6	
18	Tendergehäuse Tender body	131347	20	
19	Tendergrundrahmen lack. Tender frame coated	131349	16	
20	Griffsatnge Niro Handle bat	126870	6	
21	TS-Tenderleitern, Stang,.... Part set	126866	8	
22	Ölaufsatzsteckteil Oil tender push in part	126871	3	
23	TS-Tender Part set tender	111767	6	
24	Einfüllstutzen Filler neck	116870	3	
25	Tendergriffstange Tender handle bar	108591	4	
26	Drahtgriff Handle bar(metal)	116871	3	
27	Tendertür links kp. Tender door left ass.	114195	7	
28	Drahtstift wire nail	110641	4	
29	Tendertür rechts kpl. Tender door right ass.	114196	7	
30	Feder Spring	114197	3	
31	Platinenhalter u. Tenderkupplung Printed circuit holder a. tender coupling	111829	6	
32	Nummerntafel klein o. Abb. Number board small	131348	7	
33	Tendertürfeder Tender door spring no ill.	115554	3	
34	TS - Gewichter o. Abb. Part set weighter no ill.	129205	8	

32 o. Abb. / no ill.
Nummerntafel klein
Number board small

34 o. Abb. / no ill.
TS-Gewichte
Part set weight

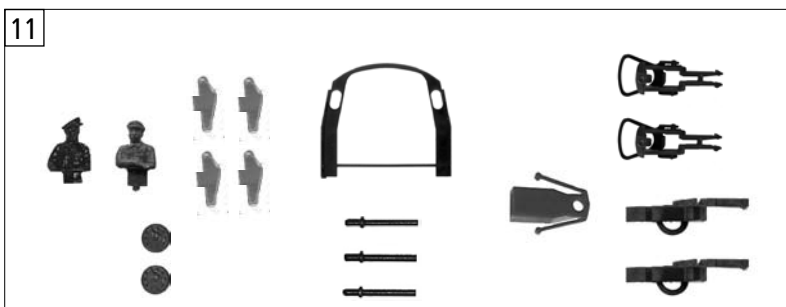
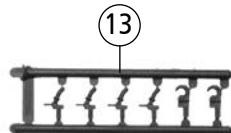
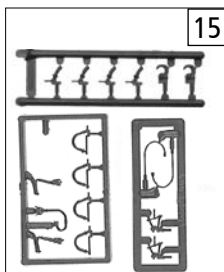
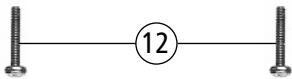
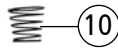
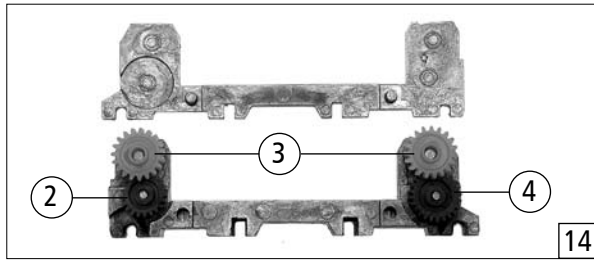
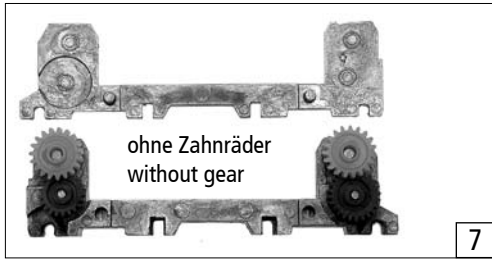

62318		DB	BR 41	=	
Pos. Nr. Pos. no.	Beschreibung Description	Art.-Nr. Art. no.	Preisgruppe Price bracket		
1	Haftringsatz 10Stk. 10,3-12,4mm Set w. traction tiers 10pieces 10,3-12,4mm	40074	---		
2	Zahnrad z=21 Gear Z=21	86414	3		
3	Schneckenzahnrad doppelt Double worm gear	86419	6		
4	Zahnrad Z=24 Gear Z=24	86516	3		
5	Radsatz o. Haftring o. Zahnrad Wheelset without traction tiers without gear	121877	9		
6	Radsatz m. Haftringen u. Zahnrad Wheelset w. traction tiers w. geara	129204	12		
7	Griebesatz Tender 2-teilig Gear set tender 2-parts	108262	11		
8	Getriebeboden Gear bottom	108263	9		
9	Blenden u. Bremsbacken Part set bogie frame a. brake shoes	117467	5		
10	Kegeldruckfeder Spring	86234	3		
11	Zurüstbeutel Bag w. accessories	126946	15		
12	GF-Schraube M2x10 GF-Screw M2x10	114854	3		
13	Attrappenrahmen Push in part set	107808	4		
14	Getriebe kpl. Gear ass.	115542	13		
15	Zurüstbeutel - Zubehörrahmen Bag w. accessories	126501	7		