

Art.-Nr.	Text	Preisgruppe
1	85033 Motor (ohne Schalen) Motor (only)	99
2	85208 Stromabnehmer Pantograph	99
3	85670 Zylinderkopfschraube M2x4 Cheese headed screw M2x4	2
4	85683 Zylinderkopfschraube M 1,7x2,5 Cheese headed screw M 1,7x2,5	2
5	86214 Feder Spring	3
6	87007 Federschale Spring coupling	4
7	87651 Platine kpl. Printed circuit assembly	39
8	88002 Lokpfeife Loco whistle	6
9	88064 Stützisolator Support insulator	2
10	88065 Isolator, Klein Insulator, small	2
11	88066 Isolator, groß Insulator, large	2
12	88067 Isolator, mitte Insulator, middle	2
13	88068 Isolator Insulator	4
14	89890 Diode Diode	8
15	91387 Fahrerhaus kpl., vorne f. 43031 Driver's cab. assy., front f. 43031	45
16	91388 Fahrerhaus kpl., hinten f. 43031 Driver's cab. assy., rear f. 43031	45
17	91389 Mitteldach kpl. f. 43031 Middle roof assy. f. 43031	22
18	91390 Gehäuse f. 43031 Body f. 43031	56
19	91425 Fahrerhaus kpl., vorne f. 43514 Driver's cab. assy., front f. 43514	45
20	91426 Fahrerhaus kpl., hinten f. 43514 Driver's cab. assy., rear f. 43514	45
21	91427 Mitteldach kpl. f. 43514 Middle roof assy. f. 43514	22
22	91428 Gehäuse f. 43514 Body f. 43514	56
23	91440 Oberleitungskontakt kpl. Overhead supply connector assembly	16
24	91441 Trafokühler, links Transformer cooling radiator, left	22
25	91442 Trafokühler, rechts Transformer cooling radiator, right	22
26	91443 Fenster, links Glazing, left	3
27	91444 Fenster, vorne Glazing, front	5
28	91445 Fenster, rechts Glazing, right	3
29	91446 Fenster (Türe) Glazing (door)	3
30	91447 Klemme, rechts Clamp, right	2
31	91448 Klemme, links Clamp, left	2
32	91449 Treppe Foot boards	2
33	91450 Kühlerschlange Cooling spiral	10
34	91451 Leitung Pipe	2
35	91452 Isolierplättchen Insulating plate	2
36	91453 Dachsteg Roof gangway	3
37	91454 Dachleitung Main roof wire	8

St. Nr.	Art.-Nr.	Text	Preisgruppe
1	10026	Glühlampe Light bulb	99
2	85709	Schraube M 1,7 Screw M 1,7	3
3	85802	Schraube M 1,4 kurz Screw M 1,4 short	2
4	86206	Federkupplung Spring coupling	5
5	86209	Druckfeder Compression spring	2
6	86409	Zahnrad Z=17, m 0.4 Gear T=17, m 0.4	2
7	86414	Zahnrad Z=21/G, m 0.4 Gear T=21/G, m 0.4	3
8	86416	Zahnrad Z=19/14, m 0.4 Gear T=19/14, m 0.4	3
9	86703	Schnecke Worm	4
10	86820	Schneckensatz Worm set	24
11	87007	Federnabe, kurz Spring hub, short	4
12	88502	Puffer, flach Buffer, flat	4
13	88503	Puffer, gewölbt Buffer, vaulted	4
14	89240	Kurzkupplungssatz (2x) Shortcouplingsset (2x)	10
15	89241	Standardkupplungssatz (2x) Standard couplingsset (2x)	10
16	89445	Treibstange Connecting rod	9
17	89823	Radkontakt Wheel contact	3
18	90277	Radsatz m. Zahnrad f. 43031 Wheelset with Gear f. 43031	20
19	90278	Radsatz o. Zahnrad f. 43031 Wheelset only f. 43031	18
20	90279	Blindwellensatz f. 43031 Blind shaft set f. 43031	16
21	90524	Radsatz o. Zahnrad f. 43514 Wheelset only f. 43514	18
22	90525	Blindwellensatz f. 43514 Blind shaft set f. 43514	16
23	90526	Radsatz m. Zahnrad f. 43514 Wheelset with gear f. 43514	20
24	91391	Getriebe kpl., vorne f. 43031 Gear assy., front f. 43031	66
25	91392	Getriebe kpl., hinten f. 43031 Gear assy., rear f. 43031	66
26	91393	Gehäuse, vorne f. 43031 Body, front f. 43031	30
27	91394	Gehäuse, hinten f. 43031 Body, rear f. 43031	30
28	91397	Getriebeboden f. 43031 Gear bottom f. 43031	20
29	91429	Getriebe kpl., vorne f. 43514 Gear assy., front f. 43514	66
30	91430	Getriebe kpl., hinten f. 43514 Gear assy., rear f. 43514	66
31	91431	Umlaufblech kpl., vorne Running board assy., front	28
32	91432	Umlaufblech kpl., hinten Running board assy., rear	28
33	91433	Getriebekasten Gear case	15
34	91434	Getriebedeckel Gear cover	15
35	91436	Zurüstbeutel Steckteile Bag with push in parts	24
36	91437	Getriebeboden f. 43514 Gear bottom f. 43514	20
37	91438	Gehäuse, vorne f. 43514 Body, front f. 43514	30
38	91439	Gehäuse, hinten f. 43514 Body, rear f. 43514	30
39	91455	Lichtleitstab Light transmission bar	5
40	91456	Schneckendeckel Worm cover	10
41	91457	Heizschlauch Heating pipe	3
42	91458	Blindwellenabdeckung, rechts Blind shaft cover, right	5
43	91459	Blindwellenabdeckung, links Blind shaft cover, left	5
44	91460	Luftbehälter Air tank	5
45	91462	Mittelpuffer Middle buffer	5
46	93394	Kupplungskammer Coupling chamber	3

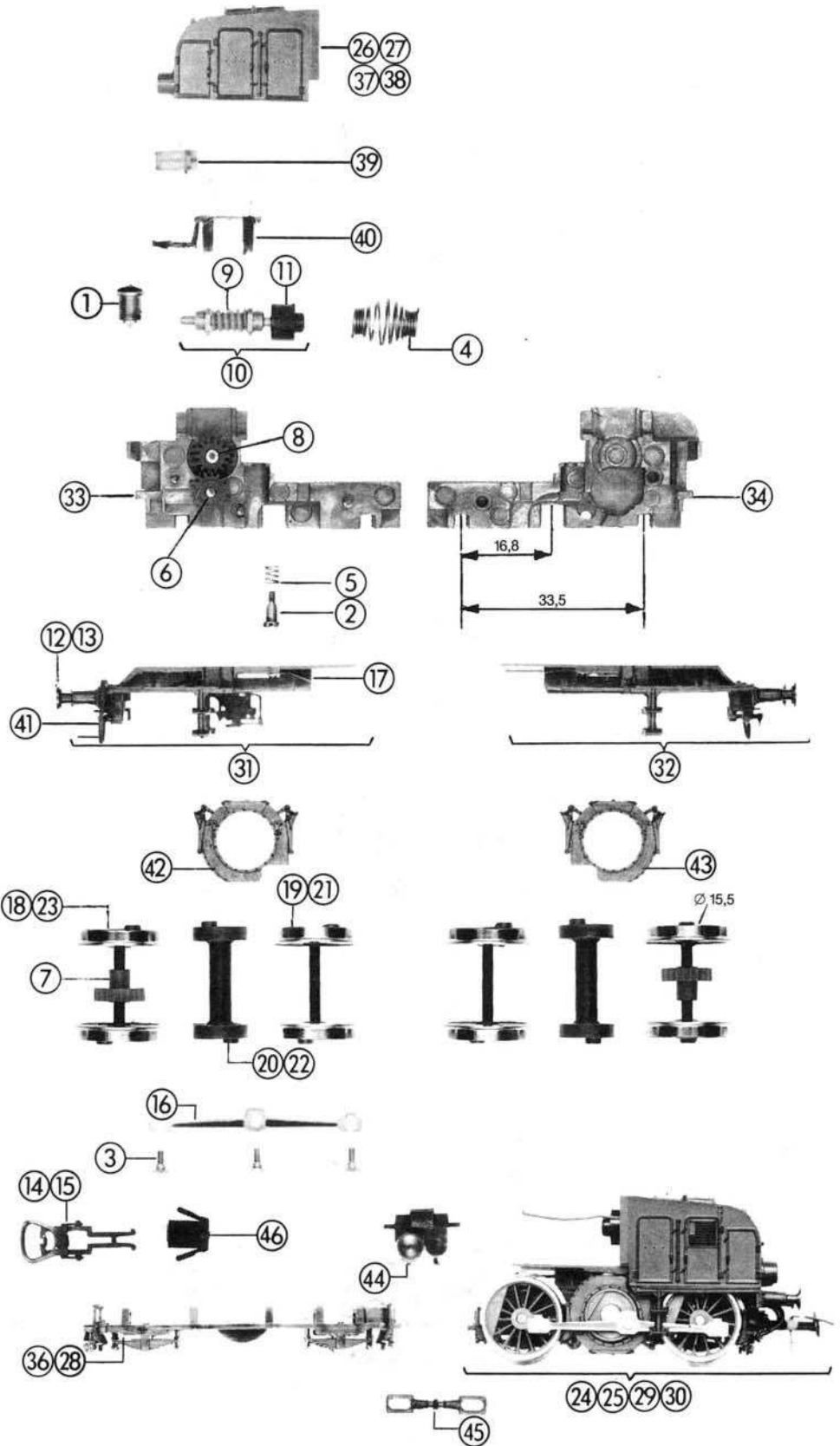

35 Zurüstbeutel-Steckteile o. Abb.
Bag with push in parts - no ill.

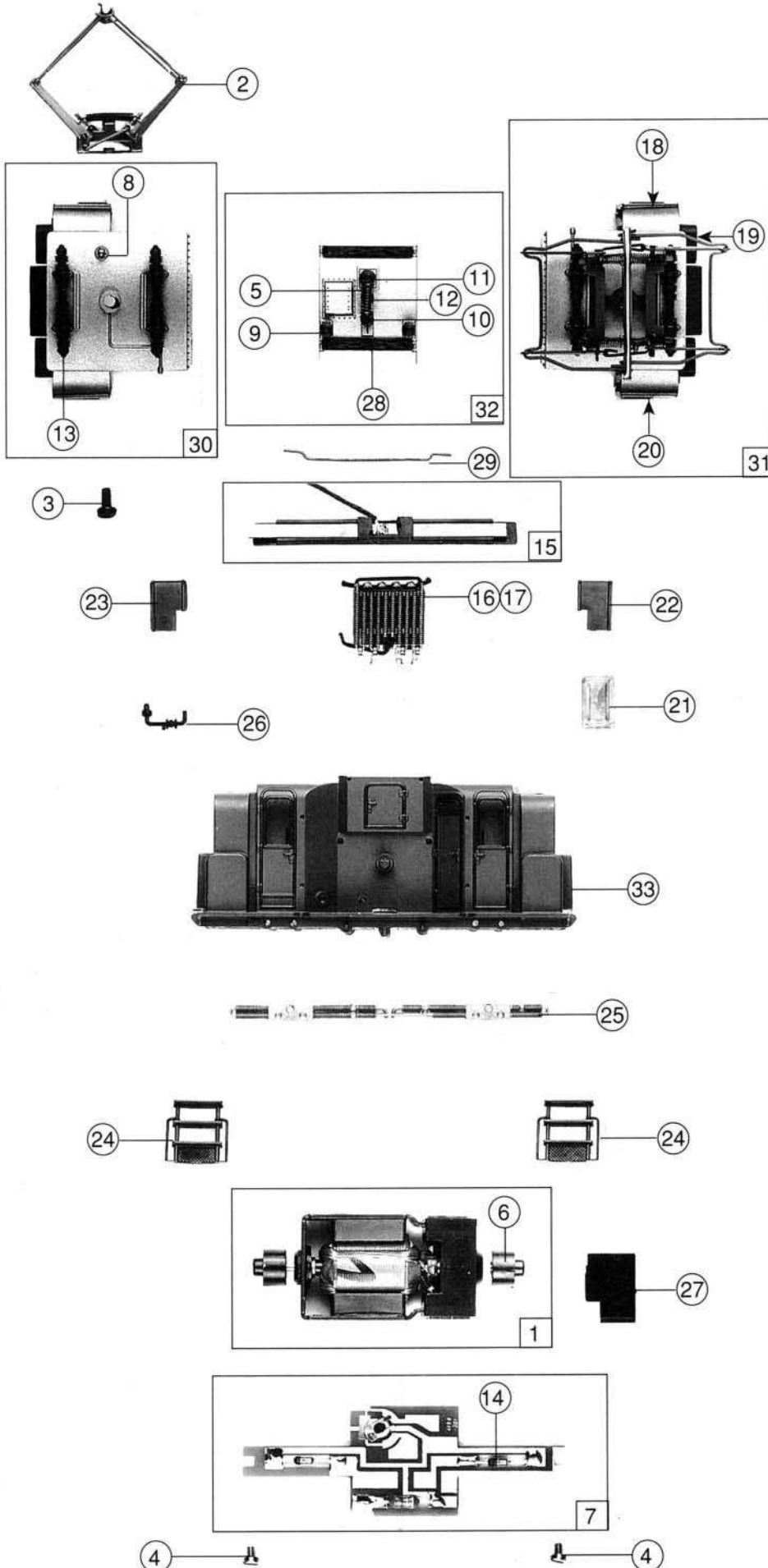

Pos. Nr.	Text	Art.-Nr.	Preis-gruppe
1	Motor <i>Motor</i>	85033	55
2	Stromabnehmer <i>Pantograph</i>	85208	29
3	Zylinderkopfschraube M 2x4 <i>Cheese headed screw M 2x4</i>	85670	2
4	Zylinderkopfschraube M 1,7x2,5 <i>Cheese headed screw M 1,7x2,5</i>	85683	2
5	Feder <i>Spring</i>	86214	3
6	Federschale <i>Spring coupling</i>	87007	4
7	Platine komplett <i>Printed circuit assembly</i>	87651	39
8	Lokpfeife <i>Loco whistle</i>	88002	6
9	Stützisolator <i>Support insulator</i>	88064	2
10	Isolator, klein <i>Insulator, small</i>	88065	2
11	Isolator, groß <i>Insulator, large</i>	88066	2
12	Isolator, mitte <i>Insulator, middle</i>	88067	2
13	Isolator <i>Insulator</i>	88068	4
14	Diode <i>Diode</i>	89890	8
15	Oberleitungskontakt komplett <i>Overhead supply connector assembly</i>	91440	16
16	Trafokühler, links <i>Transformer cooling radiator, left</i>	91441	22
17	Trafokühler, rechts <i>Transformer cooling radiator, right</i>	91442	22
18	Fenster, links <i>Glazing, left</i>	91443	3
19	Fenster, vorne <i>Glazing, front</i>	91444	5
20	Fenster, rechts <i>Glazing, right</i>	91445	3
21	Fenster (Türe) <i>Glazing (door)</i>	91446	3
22	Klemme, rechts <i>Clamp, right</i>	91447	2
23	Klemme, links <i>Clamp, left</i>	91448	2
24	Treppe <i>Foot boards</i>	91449	2
25	Kühlerschlange <i>Cooling spiral</i>	91450	10
26	Leitung <i>Pipe</i>	91451	2
27	Isolierplättchen <i>insulating plate</i>	91452	2
28	Dachsteg <i>Roof gangway</i>	91453	3
29	Dachleitung <i>Main roof wire</i>	91454	8
30	Fahrerhaus komplett, vorne <i>Drivers cab assembly, front</i>	97896	45
31	Führerhaus komplett, hinten <i>Drivers cab assembly, rear</i>	97897	45
32	Mitteldach komplett <i>Middle roof assembly</i>	97898	22
33	Gehäuse <i>Body</i>	97899	56

Pos. Nr.	Text	Art.-Nr.	Preis-gruppe
1	Schraube M 1,7 <i>Screw M 1,7</i>	85709	3
2	Schraube M 1,4 kurz <i>Screw M 1,4 short</i>	85802	2
3	Federkupplung <i>Spring coupling</i>	86206	5
4	Druckfeder <i>Compression spring</i>	86209	2
5	Zahnrad z=17; m 0,4 <i>Gear T=17; m 0,4</i>	86409	2
6	Zahnrad z=21/G; m 0,4 <i>Gear T=21/G; m 0,4</i>	86414	3
7	Zahnrad z=19/14; m 0,4 <i>Gear T=19/14; m 0,4</i>	86416	3
8	Schnecke <i>Worm</i>	86703	4
9	Schneckensatz <i>Worm set</i>	86820	24
10	Federnabe, kurz <i>Spring hub, short</i>	87007	4
11	Puffer, flach <i>Buffer, flat</i>	88502	4
12	Puffer, gewölbt <i>Buffer, vaulted</i>	88503	4
13	Kurzkupplungssatz (2x) <i>Short coupling set (2x)</i>	89240	10
14	Standardkupplungssatz (2x) <i>Standard coupling set (2x)</i>	89241	10
15	Treibstange <i>Connecting rod</i>	89445	9
16	Radkontakt <i>Wheel contact</i>	89823	3
17	Radsatz ohne Zahnrad <i>Wheelset only</i>	90524	18
18	Blindwellensatz <i>Blind shaft set</i>	90525	16
19	Radsatz mit Zahnrad <i>Wheelset with gear</i>	90526	20
20	Umlaufblech komplett, vorne <i>Running board assembly, front</i>	91431	28
21	Umlaufblech komplett, hinten <i>Running board assembly, rear</i>	91432	28
22	Getriebekasten <i>Gear case</i>	91433	15
23	Getriebedeckel <i>Gear cover</i>	91434	15
24	Zurüstbeutel Steckteile <i>Bag with push parts</i>	91436	24
25	Getriebeboden <i>Gear bottom</i>	91437	20
26	Lichtleitstab <i>Light transmission bar</i>	91455	5
27	Schneckendeckel <i>Worm cover</i>	91456	10
28	Heizschlauch <i>Heating pipe</i>	91457	3
29	Blindwellenabdeckung, rechts <i>Blind shaft cover, right</i>	91458	5
30	Blindwellenabdeckung, links <i>Blind shaft cover, left</i>	91459	5
31	Luftbehälter <i>Air tank</i>	91460	5
32	Mittelpuffer <i>Middle buffer</i>	91462	5
33	Glühlampe <i>Light bulb</i>	93521	10
34	Getriebe komplett, vorne <i>Gear assembly, front</i>	97900	66
35	Getriebe komplett, hinten <i>Gear assembly, rear</i>	97901	66
36	Gehäuse, vorne <i>Body, front</i>	97902	30
37	Gehäuse, hinten <i>Body, rear</i>	97903	30
38	Kupplungskammer <i>Coupling chamber</i>	97904	3

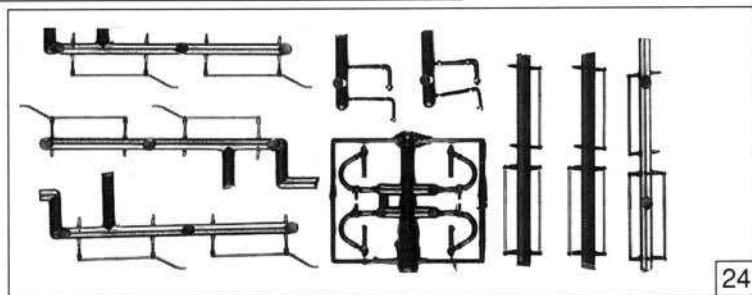
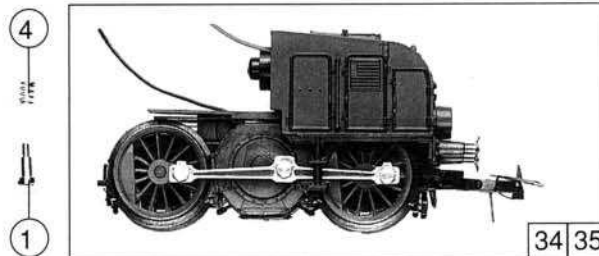
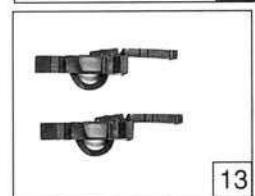
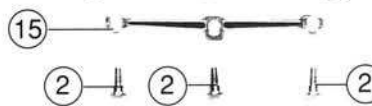
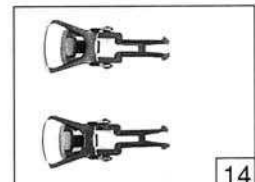
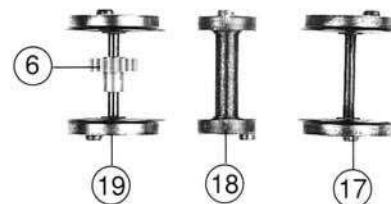
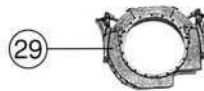
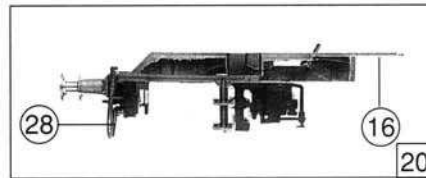
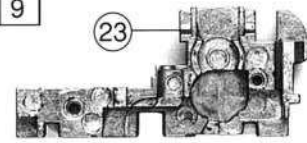
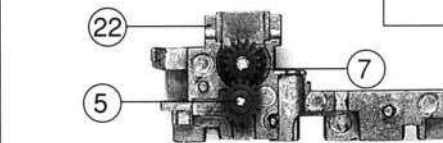
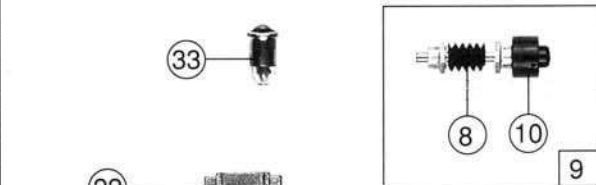
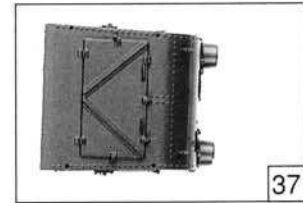
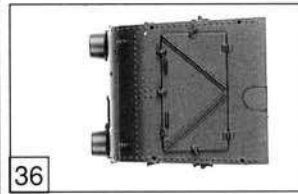



Roco

4196 (E 71)

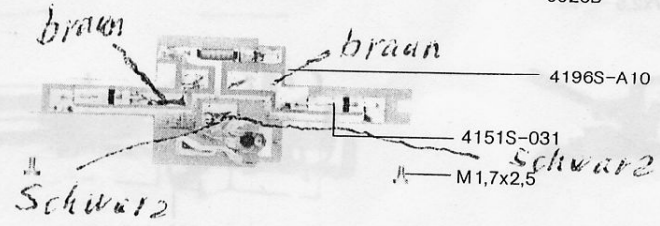
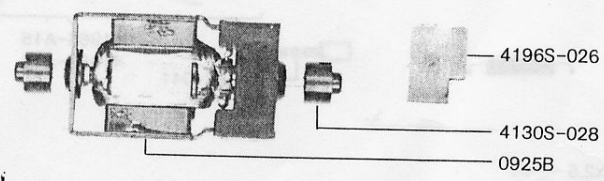
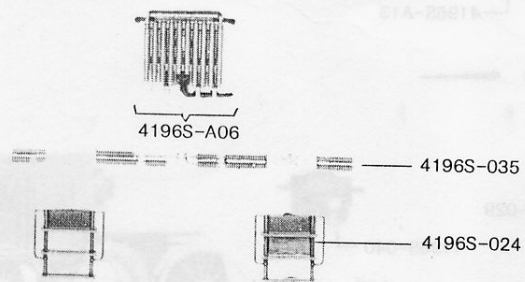
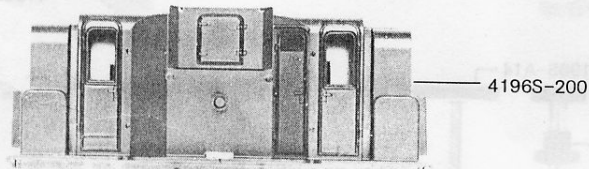
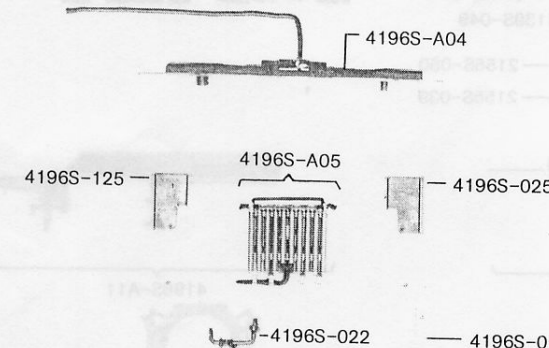
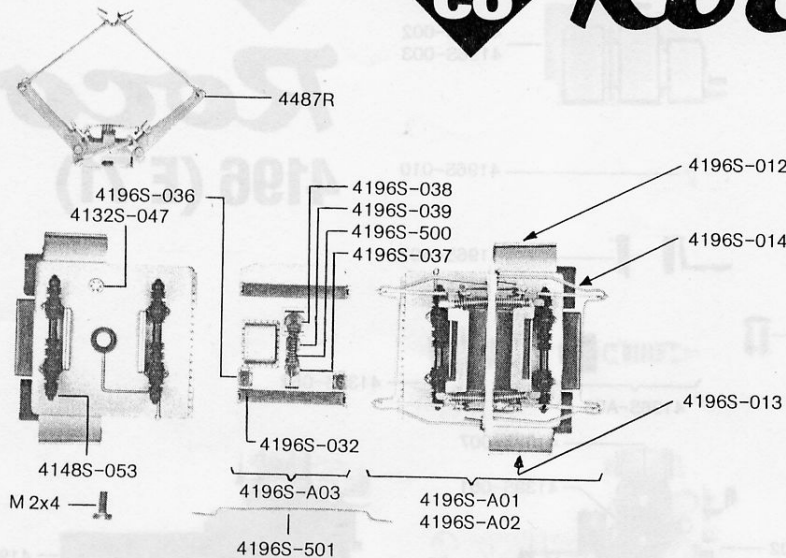

- 9142 4196S-A01 Führerhaus komplett, vorne
- 4196S-A02 Führerhaus komplett, hinten
- 9142 4196S-A03 Mitteldach komplett
- 4196S-A04 Oberleitungskontakt komplett
- 9144 4196S-A05 Trafokühler, links
- 4196S-A06 Trafokühler, rechts 9142
- 8765 4196S-A10 Platine
- 4196S-011 Fenster 91446
- 9143 4196S-012 Seitenfenster, links
- 4196S-013 Seitenfenster, rechts 9144
- 9144 4196S-014 Stirnfenster
- 4196S-022 Leitung 91451
- 9144 4196S-024 Treppe
- 4196S-025 Fensterklemmteil, rechts 91
- 9145 4196S-026 Isolierplättchen
- 4196S-032 Dachsteg 91453
- 9145 4196S-035 Kühlerschlange
- 4196S-036 Stützisolator 88064
- 8806 4196S-037 Halteisolator, klein
- 4196S-038 Halteisolator, groß 88066
- 8806 4196S-039 Mittlerer Isolator
- 4196S-125 Fensterklemmteil, links 9144
- 9142 4196S-200 Gehäuse
- 4196S-500 Feder 86214
- 9145 4196S-501 Hauptleitung
- 0925B Motor 85033
- 4130S-028 Schneckenkupplung
- 4132S-047 Lokpfeife 87002
- 8806 4148S-053 Isolator
- 4151S-031 Diode 89820
- 8520 4487R Stromabnehmer
- M 2x4 Zylinderkopfschraube
- M 1,7x2,5 Zylinderkopfschraube

- 4196S-A01 Driver's cab assembly, front
- 4196S-A02 Driver's cab assembly, rear
- 4196S-A03 Middle roof assembly
- 4196S-A04 Overhead supply connector assembly
- 4196S-A05 Transformer cooling radiator, left
- 4196S-A06 Transformer cooling radiator, right
- 4196S-A10 Printed circuit assembly
- 4196S-011 Glazing
- 4196S-012 Side glazing, left
- 4196S-013 Side glazing, right
- 4196S-014 Front glazing
- 4196S-022 Pipe
- 4196S-024 Foot boards
- 4196S-025 Window clamps
- 4196S-026 Insulating plate
- 4196S-032 Roof gangway
- 4196S-035 Cooling spiral
- 4196S-036 Support insulator
- 4196S-037 Insulator, small
- 4196S-038 Insulator, large
- 4196S-039 Middle insulator
- 4196S-125 Window clamps
- 4196S-200 Body
- 4196S-500 Spring
- 4196S-501 Main roof wire
- 0925B Motor
- 4130S-028 Worm coupling
- 4132S-047 Loco whistle
- 4148S-053 Insulator
- 4151S-031 Diode
- 4487R Pantograph
- M 2x4 Cheese headed screw
- M 1,7x2,5 Cheese headed screw



Roco

4196 (E 71)

- 456 4196S-A07 Schneckendeckel
- 4196S-A08 Schneckensatz 8920
- 4196S-A09 Umlaufblech komplett, vorne 91451
- 1432 4196S-A11 Umlaufblech komplett, hinten
- 4196S-A12 Radsatz 90103
- 0104 4196S-A13 Blindwelle
- 4196S-A14 Radsatz mit Haftreifen 90105
- 1433 4196S-A15 Getriebe komplett, vorne
- 4196S-A16 Getriebe komplett, hinten 91430
- 1435 4196S-A17 Zurüstsackerl - Kupplungen
- 1436 4196S-A18 Zurüstsackerl - Steckteile 91456
- 1438 4196S-002 Gehäuse, vorne
- 4196S-003 Gehäuse, hinten 91452
- 1435 4196S-010 Lichtleitstab
- 4196S-029 Kupplungshalter 91461
- 1437 4196S-030 Getriebeboden
- 4196S-040 Luftbehälter 91460
- 1462 4196S-041 Mittelpuffer
- 4196S-043 Blindwellenabdeckung, links 91453
- 1458 4196S-044 Blindwellenabdeckung, rechts
- 4196S-047 Heizschlauch 91457
- 472 4196S-190 Achszahnrad
- 4196S-201 Linke Getriebehälfte 91454
- 1433 4196S-202 Rechte Getriebehälfte
- 4196S-300 Treibstange 89445
- 1709 4155S-039 Zylinderkopfsatzschraube
- 5802 2155S-050 Druckfeder 86209
- 4112S-135 Sechskantkopfschraube
- 4130S-052 Federkupplung 86206
- 4132S-007 Schneckenrad
- 4139S-049 Zwischenrad 12 Z 76471
- 642 4139S-051 Zwischenrad 17 Z
- 4148S-400 Puffer, flach 88506
- 850 4148S-401 Puffer, gewölbt
- 4612S Standardkupplung 89246
- 4689S Haftring
- 4773S Glühlampe 89779
- 0318 14196S-A12 Radsatz
- 14196S-A14 Radsatz mit Haftreifen 4148S-400
- 14196S-030 Getriebeboden 4148S-401
- 4594S Schleifer
- M 1,7x2,5 Zylinderkopfschraube

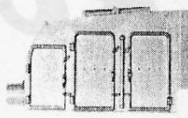

4196S-002
4196S-003



4196S-010



4196S-A07

4773S

4196S-A08

4130S-052

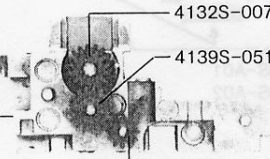

4132S-007

4139S-051

4196S-202

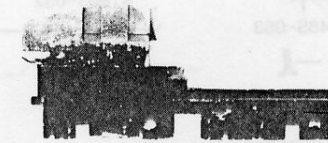

4196S-201

4139S-049

2155S-050

2155S-039

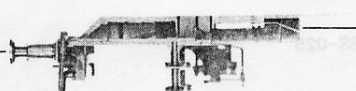

4196S-A09



4196S-A11



4196S-044

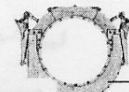

4196S-043

4196S-A12

4196S-A14

4689S

4196S-190

4196S-A13

4196S-300

4112S-135



4612S

4196S-029

4196S-040

4196S-030

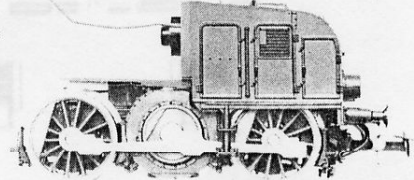

4196S-A15

4196S-A16

4196S-041

4594S

M 1,7x2,5



4196S-A17



4196S-A18

- 4196S-A07 Worm cover
- 4196S-A08 Worm set
- 4196S-A09 Buffer block assembly, front
- 4196S-A11 Buffer block assembly, rear
- 4196S-A12 Wheelset
- 4196S-A13 Blind shaft
- 4196S-A14 Wheelset w/traction tyre
- 4196S-A15 Gearcase assembly, front
- 4196S-A16 Gearcase assembly, rear
- 4196S-A17 Bag w/accessories - couplings
- 4196S-A18 Bag w/accessories
- 4196S-002 Body, front
- 4196S-003 Body, rear
- 4196S-010 Light transmission bar
- 4196S-029 Holder for coupling
- 4196S-030 Gearbottom
- 4196S-040 Air tank
- 4196S-041 Middle buffer
- 4196S-043 Blind shaft cover, left
- 4196S-044 Blind shaft cover, right
- 4196S-047 Heating pipe
- 4196S-190 Axle gear 86472
- 4196S-201 Left half of gear-box
- 4196S-202 Right half of gear-box
- 4196S-300 Connecting-rod
- 2155S-039 Cheese headed screw
- 2155S-050 Compression spring
- 4112S-135 Screw
- 4130S-052 Spring coupling
- 4132S-007 Worm gear
- 4139S-049 Gear 12 T
- 4139S-051 Gear 17 T
- 4148S-400 Buffer, flat
- 4148S-401 Buffer, vaulted
- 4612S Standard coupling
- 4689S Traction tyre
- 4773S Bulb
- 14196S-A12 Wheel set
- 14196S-A14 Wheel set w/traction tyre
- 14196S-030 Gear bottom
- 4594S Grinder
- M 1,7x2,5 Cheese headed screw