

Pos. Nr.	Text	Art.-Nr.	Preis-Gruppe
1	Sicherheitsventil Safety valve	91685	6
2	Sicherheitsventil Safety valve	91686	6
3	Lokpfeife Loco whistle	91687	6
4	Ventil Valve	91688	6
5	Rauchfangring Chimney ring	91689	6
6	Führerhausfenster, rechts Cab glazing, right	91715	5
7	Führerhausfenster, links Cab glazing, left	91716	5
8	Führerstandfenster, vorne Cab glazing, front	91717	5
9	Kesselleuchtstab Boiler light transmission bar	91719	4
10	Kesselgewicht Boiler weight	91756	20
11	Kesselstiege rechts Boiler foot board, right	106236	5
12	Kesselstiege links Boiler foot board, left	106237	5
13	Kessel komplett Betr. Nr. 2969 Boiler assembly Betr. No. 2969	106240	73
14	Führerhausstiege Cab foot board	106261	5
15	Führerhaus Betr. Nr. 2969 Cab printed Betr. No. 2969	106262	39
16	Laufsteg Running board	106263	30
17	Sanddomdeckel Sand dome cover	106264	2
18	Rauchfang Chimney	106265	5
19	Teilesatz 1 Parts set 1	106266	10
20	Teilesatz 2 Parts set 2	106267	20
21	Teilesatz 3 Parts set 3	106268	20
22	Teilesatz 4 Part set 4	106269	20
23	Teilesatz 5 Parts set 5	106270	11
24	Draht weiß 0,4 x 100 Switch rod 0,4 x 100	106271	4
25	Draht weiß 0,4 x 57,5 Switch rod 0,4 x 57,5	106272	4
26	Draht weiß 0,4 x 60 Switch rod 0,4 x 60	106273	4

43336
43873

Pos. Nr.	Text	Art.-Nr.	Preisgruppe
1	Schraube 2 x 12 Screw 2 x 12	85676	3
2	Schraube 2,2 x 6,5 Screw 2,2 x 6,5	85800	2
3	Schraube M 1,2 x 3 Screw M 1,2 x 3	85750	2
4	Sechskantschraube M 1 x 3,6 Screw M 1 x 3,6	85765	2
5	Schraube 2,2 x 9,5 Screw 2,2 x 9,5	85799	2
6	Schraube M 2 x 25 Screw M 2 x 25	85807	2
7	Distanzhülse Distance pipe	86104	5
8	Feder Spring	86229	2
9	Schneckenatz Worm set	86995	24
10	Lokplatine komplett Printed circuit assembly	87826	38
11	Kuppelstange rechts Connecting rod right	89454	9
12	Kuppelstange links Connecting rod left	89455	9
13	Kuppelstange rechts Connecting rod right	89456	9
14	Kuppelstange links Connecting rod left	89457	9
15	Lok-Leuchtstab, vorne Loco-light transmission bar, front	91718	4
16	Drahtlampe Light bulb	93520	10
17	Radsatz 5 Wheelset 5	90031	20
18	Radsatz 2 Wheelset 2	90040	20
19	Radsatz 3 Wheelset 3	90041	20
20	Radsatz 4 Wheelset 4	90053	20
21	Vorlaufadsatz Pilot wheelset	90083	16
22	Rahmen komplett Frame assembly	106212	75
23	Kardanwelle Cardan shaft	106216	4
24	Zylinderblock Cylinder block	106229	20
25	Lok-Tender Kupplung Loco-tender coupling	106230	3
26	Lichtabdeckung Light cover	106231	2
27	Luftkessel Air boiler	106232	3
28	Laufstegstütze, dünn Running board support, thin	106233	3
29	Laufstegstütze, dick Running board support, thick	106234	3
30	Laufstegstütze Running board support	106235	3
31	Lokunterteildeckel Loco base cover	106246	20
32	Lateme komplett Lantern assembly	106241	8
33	Puffer flach Buffer flat	106242	4
34	Puffer gewölbt Buffer vaulted	106243	4
35	Lok-Bremsschlauch Loco-brake pipe	106244	3
36	Lok-Kupplungsimitation Loco-coupling imitation	106245	3
37	Vorlaufdeichsel Pilot frame	106279	15
38	Radsatz 1 Wheelset 1	106800	18
39	Schleifer Collector shoe	40003	-
40	Schraube M 1,7 x 3,5 Screw M 1,7 x 3,5	85685	2
41	Lok-Platine komplett Printed circuit assembly	87695	38
42	Vorlaufadsatz Pilot wheelset	90991	14
43	Radsatz 3 Wheelset 3	90366	20
44	Radsatz 2 Wheelset 2	90369	20
45	Radsatz 4 Wheelset 4	90990	20
46	Radsatz 5 Wheelset 5	106731	20
47	Radsatz 1 Wheelset 1	106801	18

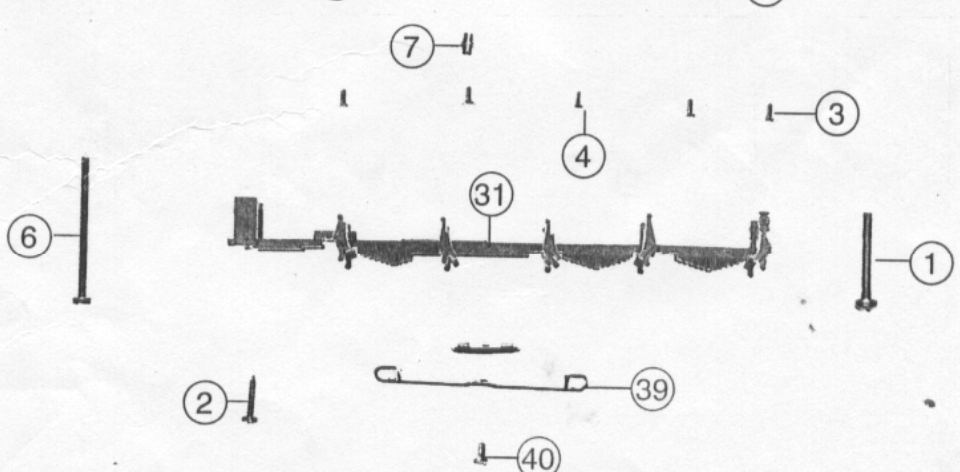
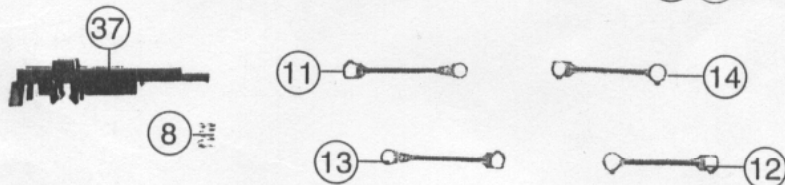
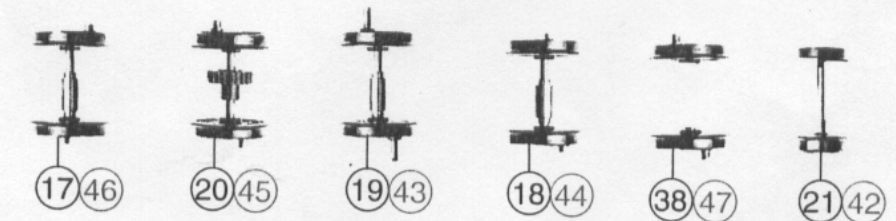
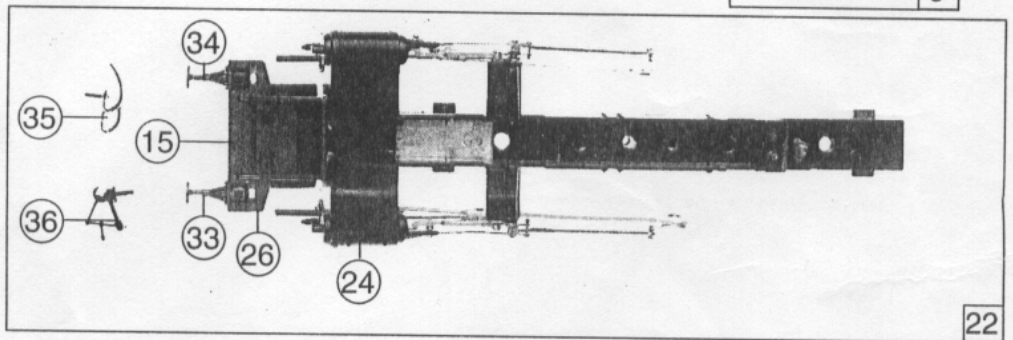
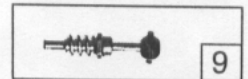
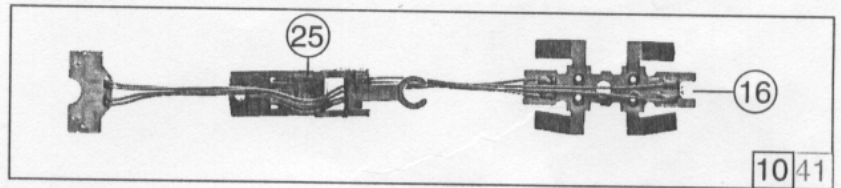
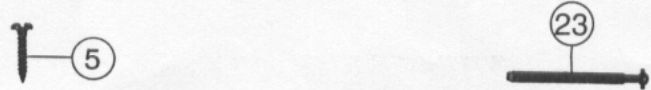
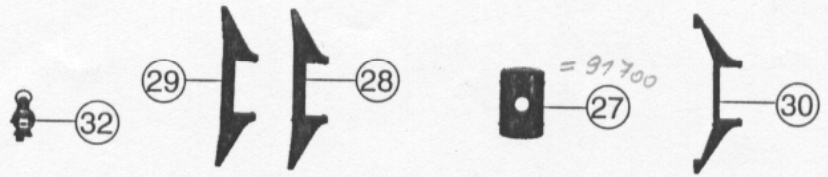

Pos. Nr.	Text	Art.-Nr.	Preis-gruppe
1	Motor Motor	85105	55
2	Halbring Traction tyre	85612	17
3	Schraube M 2 x 6 Screw M 2 x 6	85672	2
4	Schraube M 2 x 8 Screw M 2 x 8	85674	2
5	Feder Spring	86208	2
6	Zahnrad z=17, links Gear T=17, left	86409	2
7	Zahnrad z=23, rechts Gear T=23, right	86490	2
8	Zahnrad z=23, links Gear T=23, left	86460	2
9	Schnecke Worm	86720	5
10	Kardanhülse Cardan bearing	87074	4
11	Kardanschale Cardan bearing	87129	3
12	Tender Platine komplett Printed circuit assembly	87827	38
13	Kupplungs Platine Printed circuit, coupling	87828	10
14	Puffer, flach Buffer, flat	88537	4
15	Puffer, gewölbt Buffer, vaulted	88538	4
16	Universalkupplung Universal coupling	89282	5
17	Radsatz ohne Halbring Wheelset without traction tyre	90093	16
18	Radsatz mit 2 Halbtreifen Wheelset with 2 traction tyre	90086	20
19	Trittbrett, rechts Foot board, right	91734	2
20	Trittbrett, links Foot board, left	91735	2
21	Drahtlampe Lamp bulb	93520	10
22	Getriebebesatz Gear set	106223	18
23	Zurüstbeutel Bag with accessories	106274	34
24	Platinenstütze links Printed support left	106690	2
25	Platinenstütze rechts Printed support right	106691	2
26	Brückenstecker Connector	100644	7
27	Blende Gear frame	106248	35
28	Kupplungsdeichsel Coupling shaft	106255	9
29	Radsatz mit 2 Haltringen Wheelset with 2 traction tyre	90120	20
30	Umschaltmodul Switch module	89940	-
31	Radsatz mit 2 Halbtreifen Wheelset with 2 traction tyre	90008	20
32	Radsatz Wheelset	90019	16
33	Radsatz mit 2 Halbtreifen Wheelset with 2 traction tyre	90034	20
34	Brückenstecker Connector	105426	7

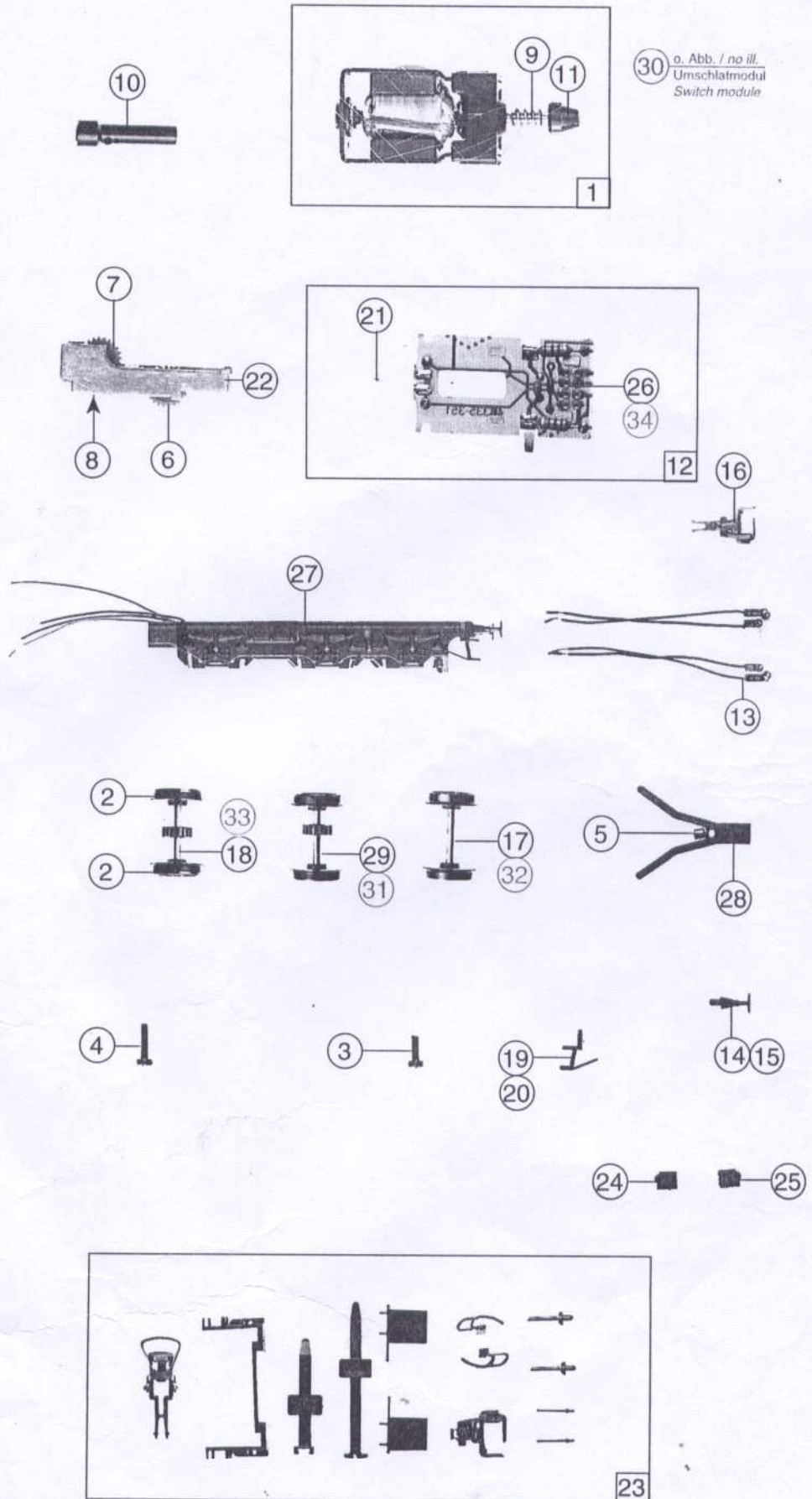

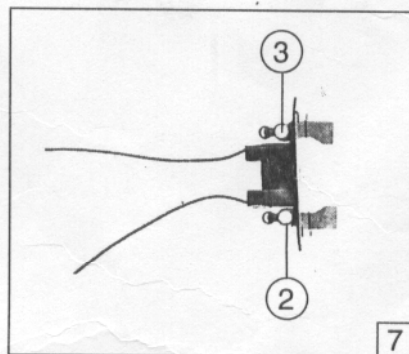
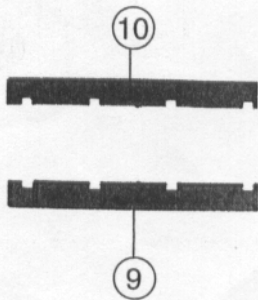
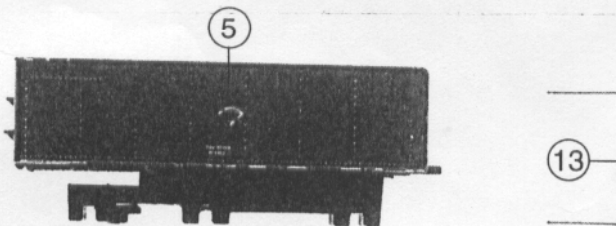
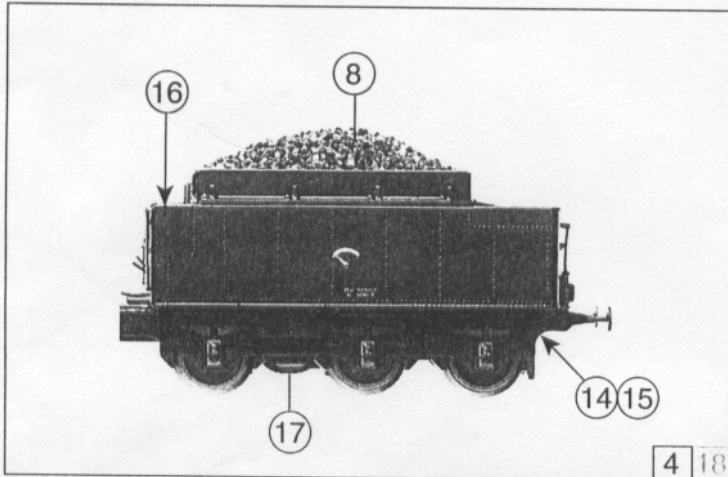
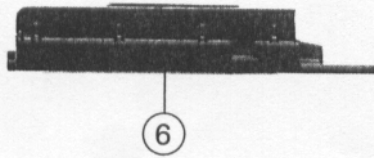

Pos. Nr.	Text	Art.-Nr.	Preis-gruppe
1	Schraube M 2 x 6 Screw M 2 x 6	85672	2
2	Leuchstab, links Light transmission bar, left	91713	4
3	Leuchstab, rechts Light transmission bar, right	91714	4
4	Tender komplett für 43336 Betr. Nr. 2969 Tender assembly for 43336 Betr. No. 2969	106239	83
5	Tenderunterteil Tender frame	106247	40
6	Kohlekastenaufsatz Coal bunker cap	106249	25
7	Kontaktträger komplett Contact carrier assembly	106250	28
8	Kohleimitation Coal imitation	106251	20
9	Kohlekastendeckel, links Coal bunker cover, left	106252	5
10	Kohlekastendeckel, rechts Coal bunker cover, right	106253	5
11	Kastendeckel Case cover	106254	2
12	Einhängebolzen Pin	106256	3
13	Griffstange, hinten Grip handle	106257	4
14	Trittbrett, rechts Step right	106258	2
15	Trittbrett links Step left	106259	2
16	Tenderhandkurbel Tender crank	106260	2
17	Zahnradabdeckung Gears bottom	106791	5
18	Tender komplett für 43873 Betr. Nr. 2969 Tender assembly for 43873 Betr. No. 2969	106275	83