

Pos. Nr. Pos.no.	Beschreibung Description	Art.-Nr. Art.no.	Preisgruppe Price bracket
1	Gehäuse komplett Nr. 2048 009-1 Body complete loco no. 2048 009-1	146743	24
2	Kardanschale kurz Cardan shell short	87129	4
3	Platine komplett Printed circuit assembly	141790	19
4	TS - Griffstangen Parts set - Handrails	113207	12
5	Motordistanzplatte Motor spacer plate	117202	3
6	Dach Roof	123311	7
7	Führerstand kpl. Drivers cab ass.	146745	6
8	Fenster für Kabine Cabine window	97911	8
9	Brückenstecker Jumper	133241	10
10	TS - Linsen Part set - Lenses	141789	8
11	UIC-Dose UIC-socket	114633	3
12	Kabine komplett Cabine complete	146744	21
13	Puffer rund flach Buffer round flat	123306	3
14	Puffer rund gewölbt Buffer round vaulted	123307	3
15	Schienenräumer Rail guard	120384	4
16	GF-Schraube M2x16 mm GF-screw	115094	3
17	Motor Motor	143272	28
18	Steuerrad Steering wheel	108732	3
19	Grundrahmen Base frame	146742	19
20	GF-Schraube M2x5 mm GF-screw	114966	3
21	Dekoderdeckel Decoder cover	123305	4
Sound			
22	Sounddecoder Sound decoder	129000	39
23	Lautsprecher Loudspeaker	129524	13
24	Soundbox Soundbox	139681	6
AC-Wechselstrom			
25	Grundrahmen Base frame	146958	19

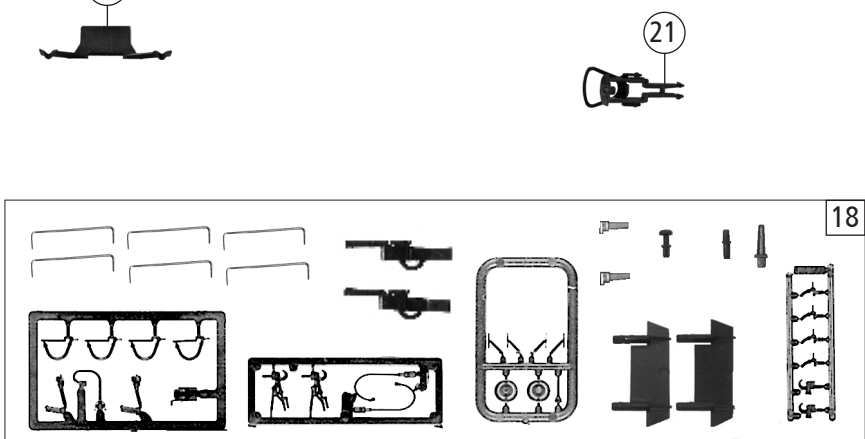
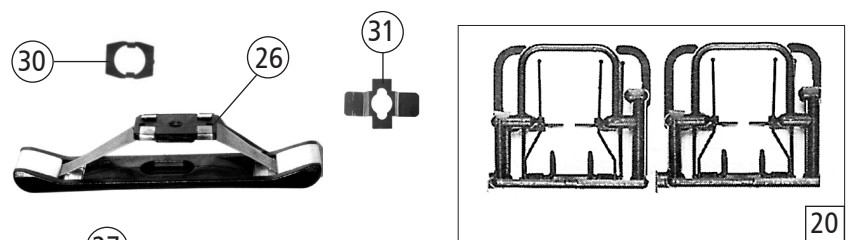
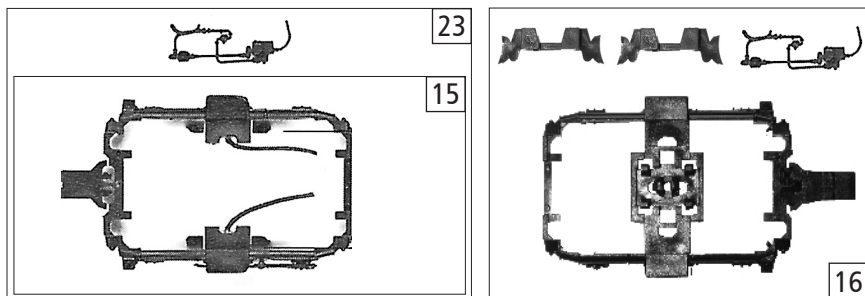
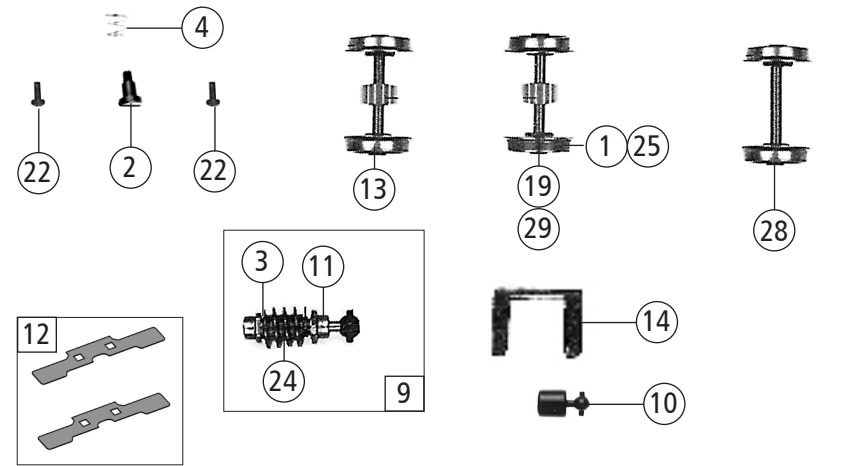
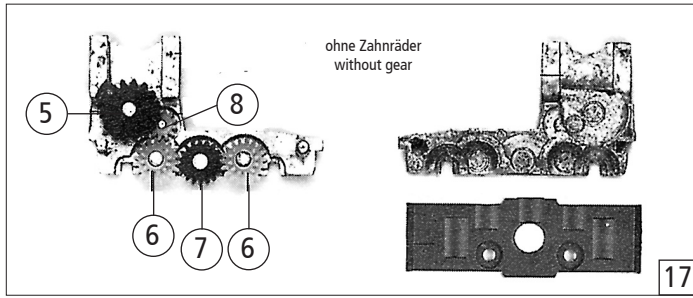

Pos. Nr. Pos.no.	Beschreibung Description	Art.-Nr. Art.no.	Preisgruppe Price bracket
52560	ÖBB BR 2048	=	
52561		=	
58561		~	
1	Hafringsatz 10Stk. 10,3-12,8mm Set with traction tires 10 pieces	40068	---
2	FK-Schraube mit Gewindeauslauf FK-Screw with back taper thread	85704	4
3	Beilagscheibe Washer	86108	3
4	Feder Spring	86202	3
5	Schneckenzahnrad doppelt Gear double	86419	6
6	Zahnrad Z=19/12 M 0.4 Gear Z=19/12 M 0.4	86424	4
7	Zahnrad Z=18 gerade M=0.4 Gear Z= 18 straight line M=0.4	86460	3
8	Zahnrad Z=12/ M 0.4 Gear Z=12/ M 0.4	86471	3
9	Schneckensatz komplett Worm set ass.	86868	13
10	Gelenkwelle Cardan shaft	87138	4
11	Lager für Schneckenachse Bearing for worm axle	89749	6
12	TS - Radkontakt Part set - Wheel contact	100050	7
13	Radsatz ohne Hafring mit Zahnrad Wheelset without traction tires with gear	90474	11
14	Schneckendeckel Worm cover	94707	4
15	Drehgestellblende kurzer Vorbau komplett Bogie frame short front end completely	120392	12
16	TS - Blendensteckteile (Teile u. Blende AC) Part set bogie push in part (part a. bogie AC)	120417	10
17	Getriebesatz ohne Zahnräder Gear set without gears	120386	13
18	Zurüstbeutel Bag with accessories	123310	13
19	Radsatz mit 2 Hafringen mit Zahnrad Wheelset with 2 traction tires with gear	107388	12
20	Aufstiegsatz Rear ladder set	146746	8
21	Standardkupplung Standard coupling	89246	6
22	GF - Schraube M2x5 mm GF - Screw	114966	3
23	Drehgestellbl. langer Vorbau komplett Bogie frame long front end completely	120394	12
24	Schnecke Wormgear	86704	6
AC - Wechselstrom			
25	Hafringsatz 10Stk. 10,3-12,4mm Set with traction tires 10 pieces 10,3-12,4	40074	---
26	Schleifer Slider	86030	14
27	Achslager Axle box	89883	6
28	HO-Wechselstromradsatz Wheelset AC	90388	7
29	Radsatz mit 2 Haftreifen AC Wheelset w. 2 traction tires AC	90476	12
30	Schleiferhalter Collector holder	116408	5
31	Kontaktblech Contact sheet plate	108722	4