

72015	NS	Sik	=	🔊		
78015			=	🔊	~	
Pos. Nr. Pos.no.	Beschreibung Description				Art.-Nr. Art.no.	Preisgruppe Price bracket
1	Gehäuse kpl. Betr. Nr. 288 Body ass. complete Loco no. 288				144825	31
2	Führerhaus Driver's cab				144826	24
3	Megaphon Megaphone				144834	3
4	Lampenhalter Lamp holder				144827	3
5	Fenster L + R Windows l + r				143929	6
6	TS - Griffe Part set - handles				144828	7
7	Rauchfang + Lüftergitter Chimnez + ventilator grills				144829	5
8	Griff Pufferbohle Buffer beam handle				144822	6
9	Vorbau Front				144830	23
10	GF-Schraube M1,6x3 mm GF - screw				143760	4
11	LED-Abdeckung LED-Cover				143936	15
12	Lautsprecher Loudspeaker				129524	14
13	Blinddeckel Blind cover				144831	4
14	Führerhausgewicht R+L Driver's cab weight r+l				144832	11
15	TS - Bremshebel Part set - brake lever				144823	6
16	Lampen L+R Lamps l+r				144824	6
17	TS - Lichtleiter+Linsen Part set - light conductor+lenses				144819	7
18	TS - Holzlaufbrett+Sandkasten Part set - wooden runway +sandbox				144820	9
19	Sandkasten hinten L+R & Pilz Sandboxes rear l+r & pin				144821	8
20	Platine PCB				143908	40

Änderungen in Konstruktion und Ausführung vorbehalten
We reserve the right to change the construction and specification

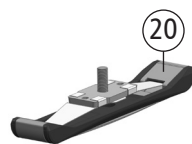
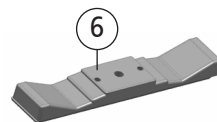
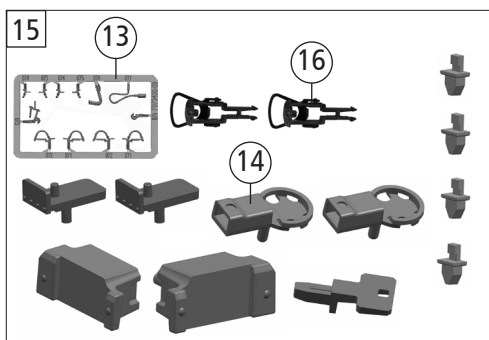
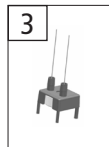
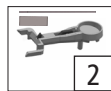
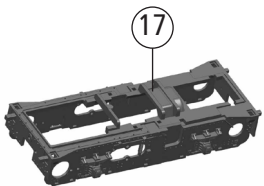
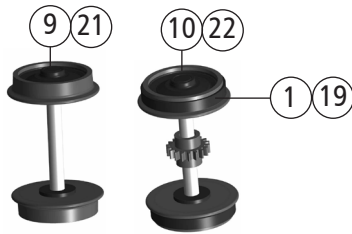
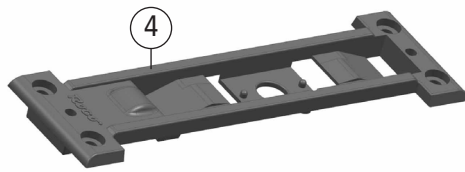
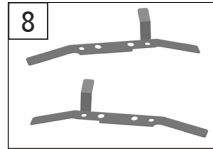
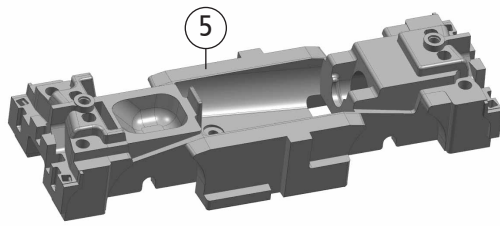

72015	NS	Sik	=	🔊	
78015			=	🔊	~
Pos. Nr. Pos.no.	Beschreibung Description		Art.-Nr. Art.no.	Preisgruppe Price bracket	
1	Hafrings.10Stk.10,3 bis 12,8m Traction tyres		40069	---	
2	TS - Digital Kupplung Part set - digital coupling		143765	10	
3	Spule kpl. Spool complete		143766	13	
4	Lokboden Loco chassis		144815	13	
5	Grundrahmen Base frame		144816	13	
6	Schleifergewicht Slider weight		143915	8	
7	Motor m. Schnecke Motor with wormgear		143770	16	
8	Radkontakt L+R Wheel contact l+r		143919	11	
9	Radsatz o. Zahnrad o. Haftring Wheelset w/o gearwheel w/o tract. tyre		144813	10	
10	Radsatz m. Zahnrad m. 2 Haftringe Wheelset w. gearwheel w. 2 tract. tyres		144814	12	
11	Puffer flach Buffer flat		131058	5	
12	Puffer gewölbt Buffer curved		131059	5	
13	TS - Bremschläuche + Zughaken Part set of brake tubes & coupling hooks		139832	7	
14	Kupplungskammer Coupling reception		143790	4	
15	Zurüstbeutel Bag of accesories		144833	16	
16	Standardkupplung Standard coupling		89246	6	
17	Blende Bogie		144818	22	
18	GF-Schraube M1,6x16 mm GF - screw		143761	4	
AC - Wechselstrom					
19	Haftreifen Traction tyres		00544007	1	
20	Schleifer Slider		86030	14	
21	Radsatz o. Zahnrad o. Haftring AC Wheelset w/o gearwheel w/o tract. tyre		144844	10	
22	Radsatz m. Zahnrad m. 2 Haftringe AC Wheelset w. gearwheel w. 2 tract. tyres		144845	12	