

Pos. Nr. Pos.no.	Beschreibung Description	Art.-Nr. Art.no.	Preisgruppe Price bracket
62445	1670		
68445		~	
1	Pantograph Pantograph	85344	38
2	Schraube M 2x7 Screw M 2x7	85673	2
3	Lokpfeife Loko whistle	88002	6
4	Puffer gewölbt rechts Bufer vaulted right	98859	4
5	Puffer flach links Buffer flat left	98860	4
6	Attrappenrahmen klein Push part set, small	107808	3
7	Isolatorsatz Insulators set	115359	8
8	TS - Führerstand-Himmel Parts set driver cab	117347	8
9	Kontakt Teller Litze 90 MM Contact plate braid 90 MM	117357	3
10	Maschinenraumfenster Engine-rom -window	117373	8
11	Griffstangensatz o.Abb. Grasp bars set no ill.	117375	19
12	Dachstegsatz Gangway set	117376	10
13	Leitung Wire	117377	2
14	Zugheizkabel Pipe for heating	117378	2
15	Umlauf Gangway	117380	2
16	Isolatorgruppe vorne Isolatorgroup front	117381	4
17	Isolatorgruppe hinten Isolatorgroup behind	117382	4
18	Isolatorgruppe kurz Insulatorgroup short	117383	4
19	Isolator f. Hauptleitung Insulator for main line	117385	2
20	Oberleitungskontakt Overhead supply connector	117386	4
21	Türgriff Hand rail	117387	3
22	Verschubgriff lackiert Displazement grasp coated	117388	4
23	Dachleitung lackiert Rof line coated	117389	13
24	Isolatorleitung Insulator line	117395	2
25	Kontakt Teller Litze 100 MM Contact plate braid 100 MM	117499	3
26	Griff klein Grasp small	117505	2
27	Gehäuse komplett Betr. Nr. 1670.25 Casing assembly Loc no. 1670.25	121810	70
28	Stirnfenster Front window	121812	5
29	Lichtnagel Lens	121813	3
30	Stromabnehmerfeder brüniert Pantograph spring browned	121815	2

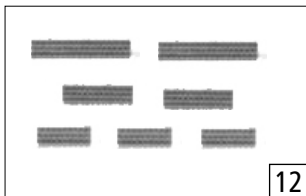

11 o. Abb. / no ill.  
Griffstangensatz  
Handrail set

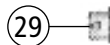
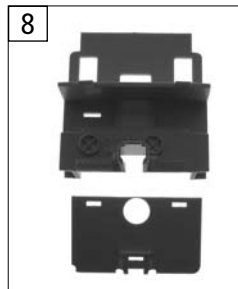
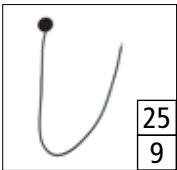
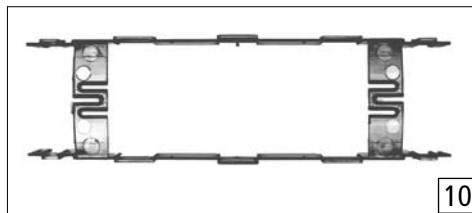
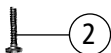
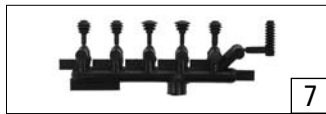
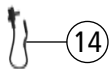

Änderungen in Konstruktion und Ausführung vorbehalten  
We reserve the right to change the construction and specification

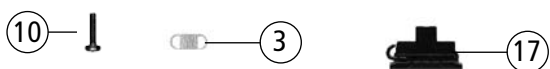
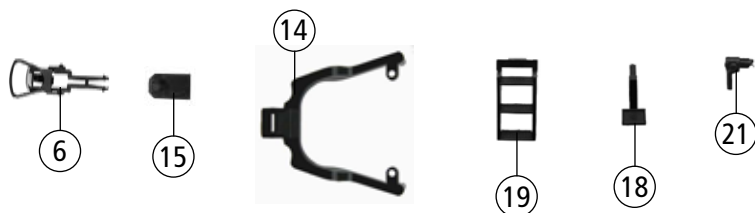
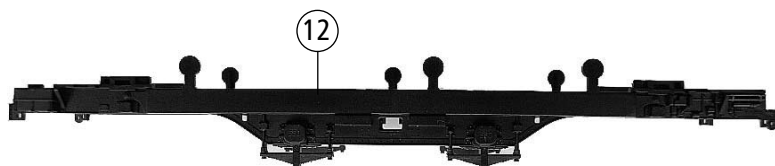
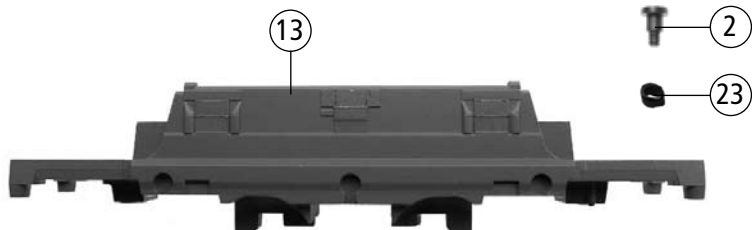
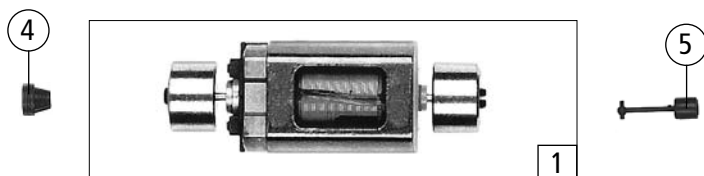
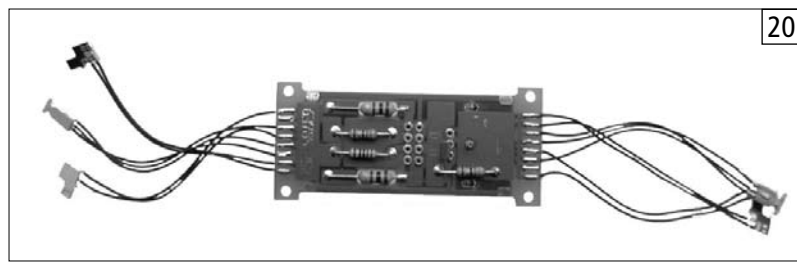

Pos. Nr. Pos.no.	Beschreibung Description	Art.-Nr. Art.no.	Preisgruppe Price bracket
1	Motor Motor	85111	57
2	FK-Schraube mit Gewindeauslauf FK-Screw	85704	2
3	Zugfeder Spring	86208	2
4	Kardanschale kurz 1,5mm Cardan shell short 1,5mm	87129	3
5	Kardanwelle kurz Cardan shaft short	87171	2
6	Standardkupplung kpl. Standard coupling assembly	89246	5
7	Brückenstecker Connector	100644	7
8	Distanzplättchen Spacer	106116	2
9	GF-Schraube M2x4 GF-Screw M2x4	114877	2
10	GF-Schraube M1,6x8 GF-Screw M1,6x8	115026	2
11	Kontaktfeder Spring	116876	2
12	Rahmen Frame	117345	8
13	Grundrahmen Main frame	117346	29
14	Deichsel Holder for coupling	117348	3
15	Kupplungskammer Coupling chamber	117350	3
16	Teilesatz Parts set	117351	6
17	Indusi Indusi	117352	2
18	Auftritt Step	117353	2
19	Treppe Step	117355	2
20	Motorplatine komplett m. LED-PI Printed circuit assembly with LED-PI	123331	53
21	Dose Socket	117379	2
22	Gewicht Weight	117600	20
23	Federschlauch Tube	121808	4
<b>AC - Wechselstrom</b>			
24	Lokdecoder Motorola Decoder Motorola	10738	---

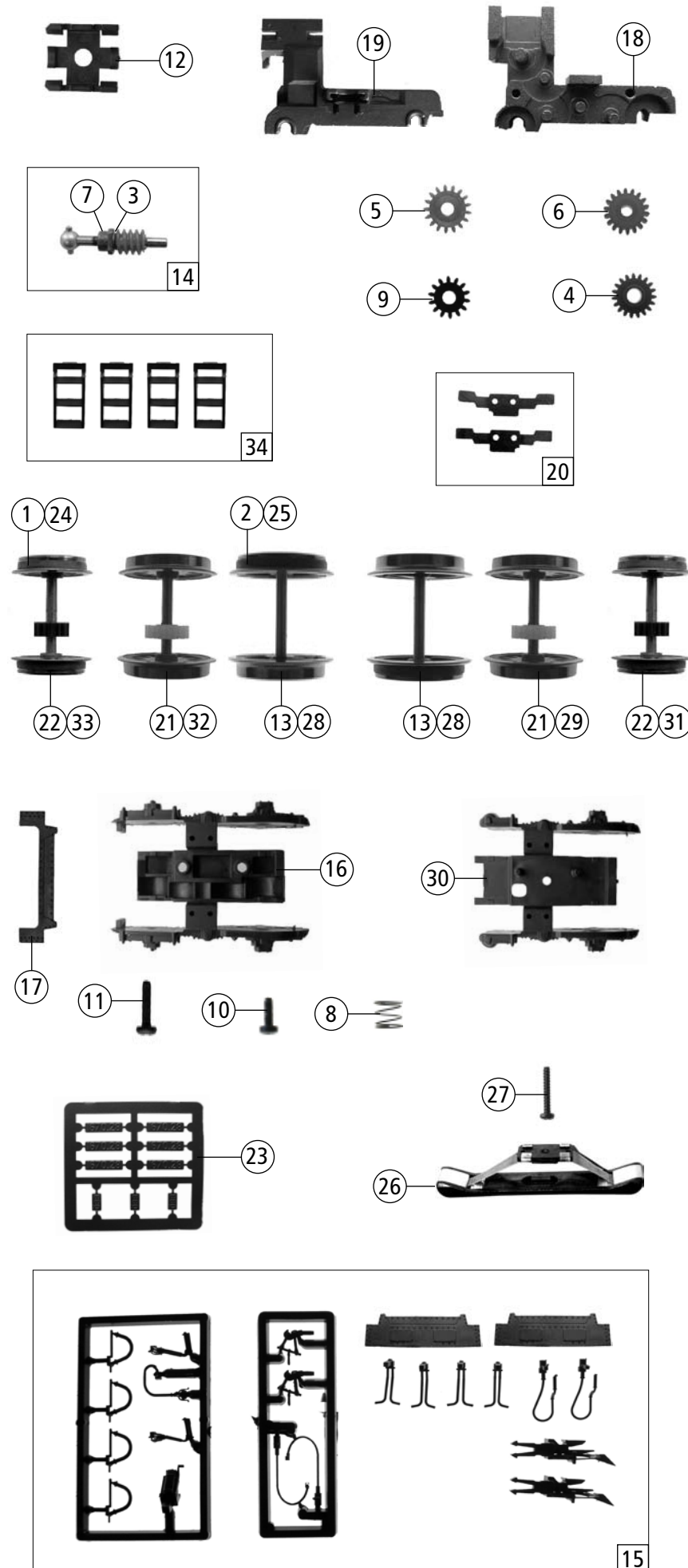

Pos. Nr. Pos.no.	Beschreibung Description	Art.-Nr. Art.no.	Preisgruppe Price bracket
62445	1670		
68445		~	
1	Hafringsatz 10Stk. 10,3-12,8mm Set with traction tires 10 pieces	40069	---
2	Hafringsatz 10Stk. 12,9-14,6mm Set with traction tires 10 pieces	40070	---
3	Beilagscheibe 2.1x4/0.2 mm Washer disk 2.1x4/0.2 mm	86108	2
4	Zahnrad Z=19/14 M-0.4 Gear z=19/14 M-0.4	86416	3
5	Zahnrad Z=17/0.4 G Gear Z=17/0.4 G	86418	2
6	Zahnrad Z=18 M-0.4 G Gear Z=18 M-0.4 G	86460	2
7	Lager für Schneckenachse Bearing for Worm axle	89749	6
8	Laufgestelldruckfeder Spring	108226	2
9	Zahnrad Z=14 Gear Z=14	111115	2
10	GF - Schraube M2x6 GF - Screw M2x6	114828	2
11	GF - Schraube M2x8 GF - Screw M2x8	114923	2
12	Schneckendeckel Wormcover	117349	3
13	Radsatz 3+4 mit 1x Hafring Wheelset 3+4 with 1x traction tyre	117356	20
14	Schneckensatz komplett Worm set assembly	117359	24
15	Zurüstbeutel Bag with accessories	117361	24
16	Blende Bogie	117363	10
17	Frontblech ausgeschnitten Front plate cut out	117364	5
18	Getriebe Gear case	117365	15
19	Getriebedeckel Gear cover	117366	10
20	Radkontaktsatz Wheel contact set	117367	4
21	Radsatz 2+5 ohne Hafring Wheelset 2+5 without traction tyre	117368	18
22	Radsatz 1+6 klein mit Hafring Wheelset 2+5 small with traction tyre	117370	20
23	Tafelsatz lackiert Numberset coated	121811	20
<b>AC - Wechselstrom</b>			
24	Hafringsatz 10Stk. 10,3-12,4mm Set with traction tires 10 pieces	40074	---
25	Hafringsatz 10Stk. 12,5-15,3mm Set with traction tires 10 pieces	40075	---
26	AC - Schleifer Collector	86030	---
27	GF - Schraube 1.6x6 GF - Screw 1.6x6	114836	2
28	AC - Mittelradsatz mit Hafring AC - Wheelset with traction tyre	117396	20
29	Radsatz AC ohne Hafring Wheelset AC without traction tyre	117397	16
30	Blende Bogie	117398	10
31	Radsatz AC klein ohne Hafring Wheelset AC small without traction tyre	117399	16
32	Radsatz AC mit Hafring Wheelset AC with traction tyre	117400	20
33	Radsatz AC klein mit Hafring Wheelset AC small with traction tyre	117401	20
34	Zurüstbeutel Treppen Bag with accessories steps	121809	4

Ersatzteile erhalten Sie bei Ihrem Fachhändler, oder Ihrer Landesvertretung.  
You can order your Replacement Parts at your local dealer, your country representative.