

Pos. Nr.	Text	Art.-Nr.	Piecs. / pieces
1	Stromabnehmer <i>Pantograph</i>	85347	36
2	Schraube M 2 x 6 <i>Screw M 2 x 6</i>	85672	2
3	Schraube 2,2 x 6,5 <i>Screw 2,2 x 6,5</i>	85800	2
4	Stützisolator (7) <i>Insulator (7)</i>	88001	2
5	Lokpfeife <i>Loco whistle</i>	88002	6
6	Senkantrieb <i>Hoise mechanism</i>	88007	2
7	Stützisolator (4) <i>Insulator (4)</i>	88010	2
8	Druckluftschalter <i>Pressure cab switch</i>	88024	2
9	Antenne <i>Antenna</i>	88030	4
10	Puffer flach <i>Buffer flat</i>	88502	6
11	Puffer gewölbt <i>Buffer vaulted</i>	88503	6
12	Lokführer <i>Loco driver</i>	89732	5
13	Dachleitung <i>Roof wire</i>	92731	10
14	Gühlampe <i>Light bulb</i>	93519	10
15	Fenstersatz <i>Glazing set</i>	100577	15
16	Stützisolator <i>Insulator</i>	100586	2
17	Brückenstecker <i>Connector</i>	100644	7
18	Führerstand <i>Drivers cab</i>	101293	6
19	Oberleitungsverbinder <i>Overhead supply conn.</i>	106925	6
20	Etikette Silber <i>Label silver</i>	108697	2
21	Platine komplett <i>Printed circuit assembly</i>	108804	43
22	Dachaufsatz <i>Roof top</i>	108807	10
23	Lichtleitstäbesatz <i>Light transmissions bar set</i>	108808	14
24	Gehäuse komplett f. 43387 Betr. Nr. 140 386-4 Body assembly f. 43387 Betr. No. 140 386-4	108957	68

Pos. Nr.	Text	Art.-Nr.	Preis-Gruppe
1	Motor komplett <i>Motor assembly</i>	85060	57
2	Halfringesatz <i>Traction tyre set</i>	85622	19
3	Zahnrad z=14l, m 0,4 <i>Gear T=14l, m 0,4</i>	86407	2
4	Schnecke <i>Worm</i>	86701	5
5	Schneckenatz komplett <i>Worm set assembly</i>	86842	24
6	Kardanschale <i>Cardan bearing</i>	87093	3
7	Universalkupplung <i>Universal coupling</i>	89282	5
8	Radsatz <i>Wheelset</i>	90517	18
9	Inneneinrichtungssatz <i>Interior set</i>	100010	10
10	Radkontaktsatz <i>Wheel set</i>	100012	8
11	Zahnradatz <i>Gear set</i>	100014	20
12	Getriebesatz komplett <i>Gear part assembly</i>	100581	24
13	Kupplungshalter <i>Coupling holder</i>	100829	2
14	Drehgestell 1 komplett <i>Bogie 1 assembly</i>	101295	53
15	Drehgestell 2 komplett <i>Bogie 2 assembly</i>	101296	53
16	Drehgestellblende 1 komplett <i>Bogie frame 1 assembly</i>	101297	30
17	Drehgestellblende 2 komplett <i>Bogie frame 2 assembly</i>	101298	30
18	Steckteilesatz <i>Push in parts set for bogie</i>	101299	20
19	Lokrahmen <i>Loco frame</i>	108803	30
20	Radsatz mit 2 Halfringen <i>Wheelset with 2 traction tyre</i>	108806	20
21	Zurüstbeutel <i>Bag with accessories</i>	108809	25
22	Werkzeugkasten <i>Loco bottom</i>	108811	5
23	Kühlspirale mit Zylinder <i>Radiator hose with cylinder</i>	108812	3

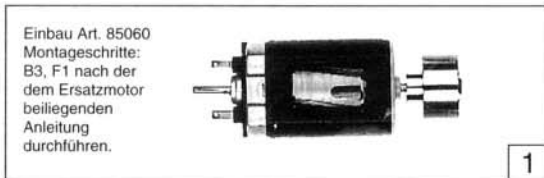

22 o. Abb./ no. ill.  
Werkzeugkasten  
Loco Bottom

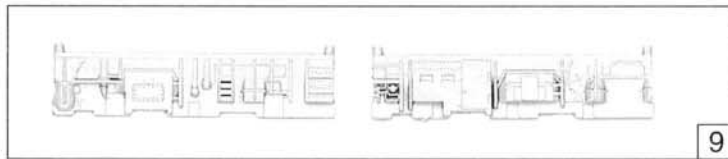
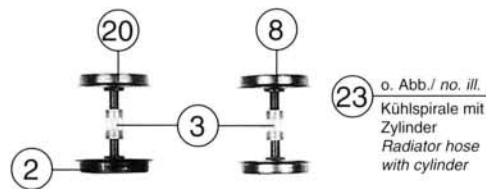
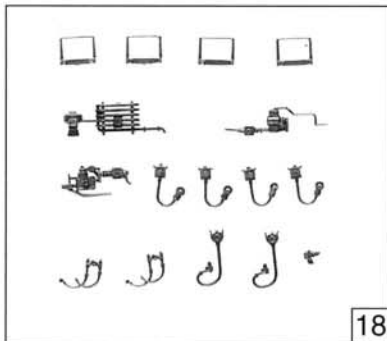
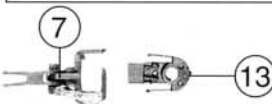
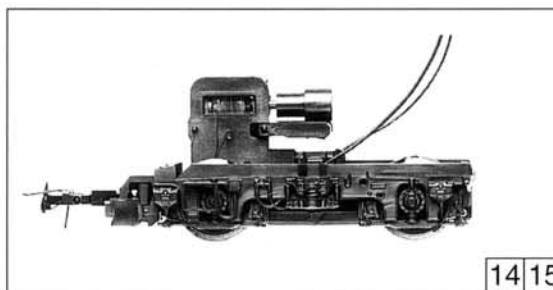
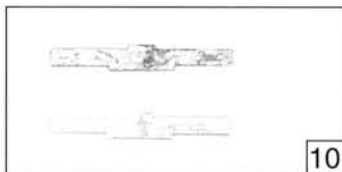
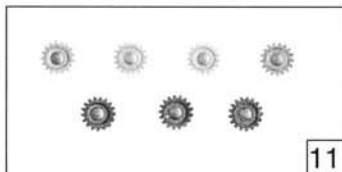
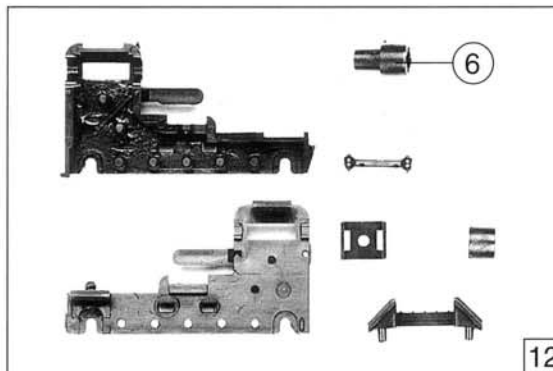
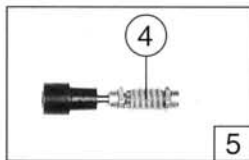
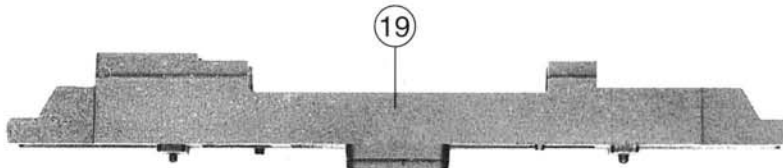

23 o. Abb./ no. ill.  
Kühlspirale mit  
Zylinder  
Radiator hose  
with cylinder

