

Pos. Nr.	Text	Art.-Nr.	Preis-gruppe
1	Laufsteg Gangway	91928	30
2	Luftdruckpumpe Pneumatic pump	91540	3
3	Wasserspeisepumpe Water feeder pump	91943	3
4	Behälter Tank	91944	3
5	Hebel für Umschalter Switch lever	91946	3
6	Zylinderschutzrohr Cylinder protection tube	91949	2
7	Zylindereinsatz Slide insert	101492	2
8	Handgriff Griphandle	91961	2
9	Handgriff links Griphandle left	91962	2
10	Handgriff rechts Griphandle right	91963	2
11	Lokpfeife Loco whistle	91981	3
12	Handrad Hand wheel	91983	3
13	Führerhaussteckteil links Water feeder left	91984	5
14	Führerhaussteckteil rechts Water feeder right	91985	5
15	Sanddomainsatz Sanddome cover	92342	3
16	Ventil mit Loch Valve with hole	92344	5
17	Ventil ohne Loch Valve without hole	92345	5
18	Stangenventil Rod valve	92346	5
19	Doppelstangenventil Double valve	92347	5
20	Rohr 1 Pipe 1	92349	3
21	Rohr 2 Pipe 2	92350	3
22	Griffstangenöse Switch rod bearing	92351	2
23	Griffstange 0,4 x 31 Switch rod 0,4 x 31	92352	2
24	Griffstange 0,4 x 86 Switch rod 0,4 x 86	92353	2
25	Ventilschaltachse 0,4 x 70 Switch rod axle 0,4 x 70	92354	2
26	Ventilschaltachse 0,4 x 89 Switch rod axle 0,4 x 89	92355	2
27	Domeinsatz Dome cover	94023	3
28	Inneneinrichtung Interior detail	101259	18
29	Ventilhandratsatz Valve set	101261	10
30	Steuerung komplett Steering assembly	101262	70
31	Zylinderblock Cylinder block set	101263	20
32	Kessel komplett Betr. Nr. 17 1177 Boiler assembly Betr. No. 17 1177	101279	73
33	Führerhaus komplett Betr. Nr. 17 1177 Cab assembly Betr. No. 17 1177	101280	35
34	Windleitblech Stütze Smoke deflector holder	101281	2
35	Doppelventil Double valve	101284	2
36	Doppelstangenführung Double valve	101285	2
37	Schlauchventil Tube valve	101286	2

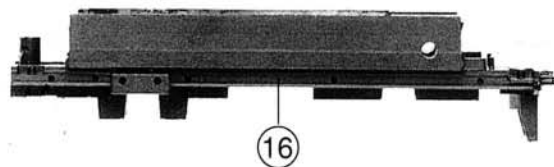

Pos. Nr.	Text	Art.-Nr.	Preisgruppe
1	Motor komplett <i>Motor assembly</i>	85096	57
2	Schnecke <i>Worm</i>	86713	5
3	Platine komplett <i>Printed circuit</i>	87788	30
4	Blende <i>Frame</i>	91932	12
5	Tenderseitendeckel groß <i>Cover big</i>	91951	3
6	Tenderseitendeckel klein <i>Cover small</i>	91952	3
7	Handgriff <i>Grip handle</i>	91965	2
8	Tenderstufe hinten <i>Tender steps rear</i>	91966	3
9	Tenderstufe links <i>Tender steps left</i>	91967	3
10	Tenderstufe rechts <i>Tender steps right</i>	91968	3
11	Wasserrohr <i>Tender water pipe</i>	91986	3
12	Kohlekasten <i>Simulated coal</i>	92341	15
13	Glühlampe <i>Light bulb</i>	93518	12
14	Fenster-Lichtleitstäbesatz <i>Glazing set</i>	101260	20
15	Tender Lampensatz <i>Lightning set</i>	101272	28
16	Tenderunterteil <i>Tender lower part</i>	101273	30
17	Tenderbremszylinder <i>Brake cylinder</i>	101277	3
18	Tender komplett Betr. Nr. 17 1177 <i>Tender assembly</i> Betr. No. 17 1177	101282	82
19	Tendergehäuse Betr. Nr. 17 1177 <i>Tender body</i> Betr. No. 17 1177	101283	41

Pos. Nr.	Text	Art.-Nr.	Preis-gruppe
1	Hafttring <i>Traction tyre</i>	85612	17
2	Schraube 2 x 12 <i>Screw 2 x 12</i>	85676	2
3	Schraube 2 x 14 <i>Screw 2 x 14</i>	85694	2
4	Beilagscheibe <i>Washer</i>	86084	2
5	Achszahnrad <i>Gear</i>	86401	2
6	Zahnrad z/14 re. <i>Gear T/14 ri.</i>	86403	2
7	Zahnrad z/14 li. <i>Gear T/14 le.</i>	86404	2
8	Zahnrad z=17 <i>Gear T=17</i>	86405	2
9	Standard Kupplung <i>Standard coupling</i>	89203	5
10	Tenderradsatz ohne Hafttring <i>Wheelset without traction tyre</i>	90901	18
11	Tenderradsatz mit Hafttring <i>Wheelset with traction tyre</i>	90902	20
12	Zurüstbeutel <i>Bag with accessories</i>	101267	28
13	Tenderkontaktsatz <i>Contact set</i>	101271	22
14	Zurüstbeutel 2 <i>Bag with accessories 2</i>	101274	18
15	Teilesatz 1 <i>Push in partset 1</i>	101276	12
16	Schiebereinsatz <i>Slide insert</i>	91948	2

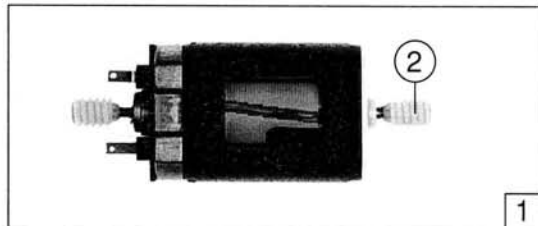
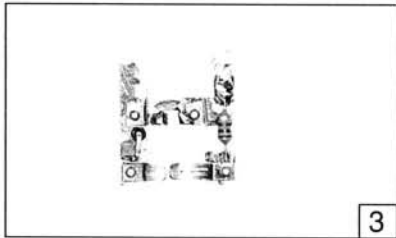
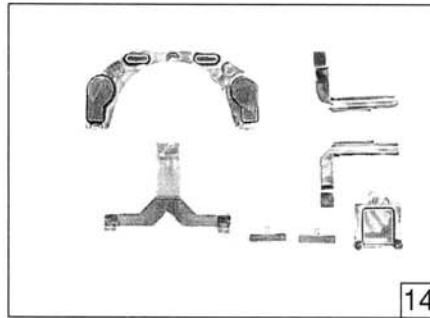
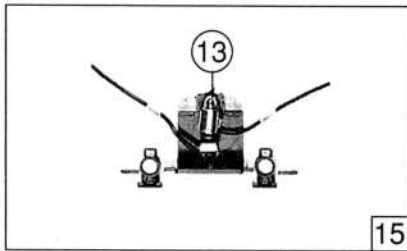
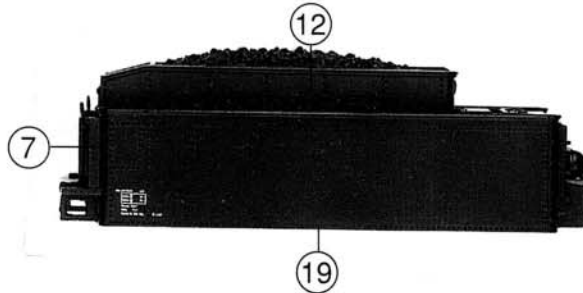
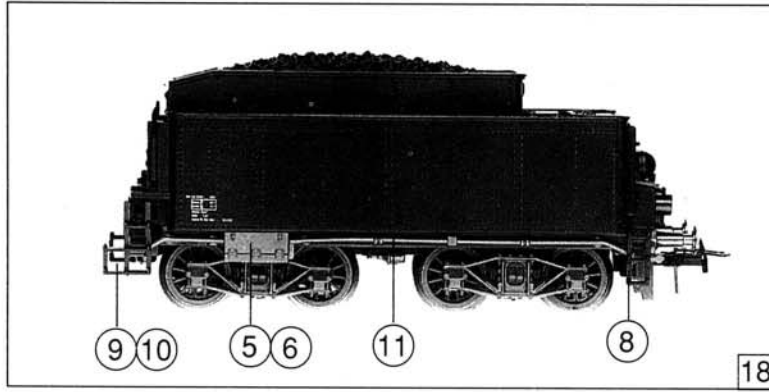