

23

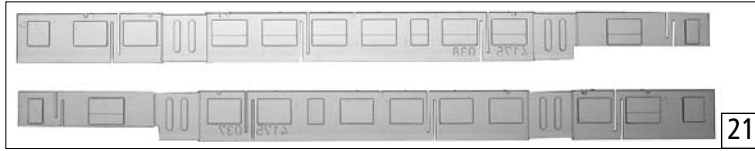

21

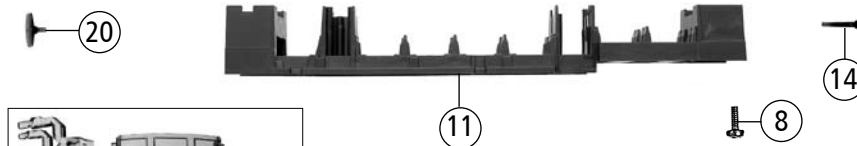

20

14



19

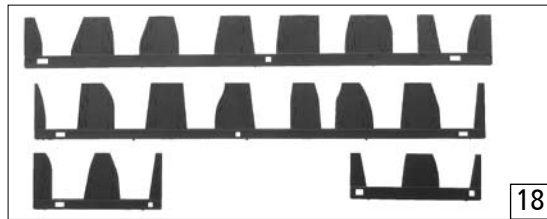

18

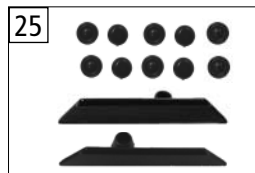

25



9

9

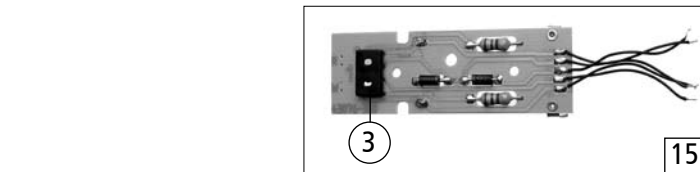

3

15

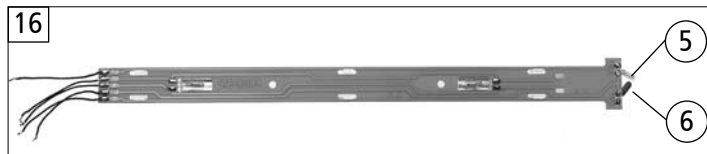

16

5

6

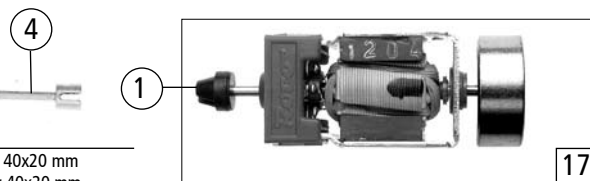

4

1

17

24 o. Abb. / no ill.
Lautsprecher 40x20 mm
Loud speaker 40x20 mm
Les haut-parleurs 40x20mm

26 o. Abb. / no ill.
Sounddecoder Version 3.5
Sounddecoder Version 3.5
Décodeur version 3.5



12

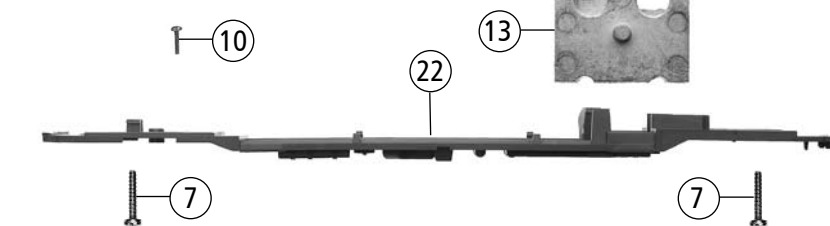

10

13

22

7

7

Pos. Nr. Pos.no. Position	Beschreibung Description Désignation	Art.-Nr. Art.no. Réf.	Preisgruppe Price bracket Catégorie de prix
43083	X2800	=	
43084		=	
1	Kardanschale kurz Cardan bearing short Tulipe du Cardan	87129	3
2	Führerstand Cab Cabine de conduite	95298	6
3	Brückenstecker Connector Fiche de shuntage	100644	7
4	Kardanwelle Cardan shaft Arbre à Cardan	107011	3
5	Drahtlampe T3/4 16V 30mA Light bulb T3/4 16V 30mA Ampoule à électrodes 16V	108616	10
6	Drahtlampe rot T3/4 16V Light bulb red T3/4 16V Ampoule à électrodes 16V rouge	110479	10
7	GF-Schraube M2x6 GF-Screw M2x6 GF-Vis M2x6	114828	2
8	GF-Schraube M2x8 GF-Screw M2x8 GF-Vis M2x8	114923	2
9	GF-Schraube M2x5 GF-Screw M2x5 GF-Vis M2x5	114966	2
10	GF-Schraube M1,6x5 GF-Screw M1,6x5 GF-Vis M1,6x5	115269	2
11	Inneneinrichtung Interior Aménagement intérieur	115588	7
12	Gewicht Motorseite Weight motor side Poids	115589	13
13	Gewicht hinten Weight rear Poids	115590	9
14	Puffer lang Buffer long Plateau étroit de tampon en long	115593	2
15	Platine komplett Triebwagen Printed circuit assembly motor coach circuit imprimé complet	115594	39
16	Innenbeleuchtung kpl. Interior Lighting set Éclairage intérieur complet	115595	36
17	Motorbaugruppe Motor Moteur complet	115596	55
18	Vorhangsatz Curtain set Courtine kit	115602	6
19	Stirfen.-Lichtleitsatz Front window-light transmission set Vol d'accessoires	115622	7
20	Puffer kurz Buffer short Plateau étroit de tampon court	115623	2
21	Fenstersatz Window set Fenetre kit	115624	17
22	Bodenplatte Bottom plate Chassis	115628	8
23	Gehäuse komplett 2844 Body ass. 2844 Caisse complet 2844	125890	61
Sound 43084			
24	Lautsprecher 40x20 mm Loud speaker 40x20 mm Les haut-parleurs 40x20mm	112630	31
25	TS - Gehäuse lackiert Part set body coated Kit laquée pour Caisse	121367	7
26	Sounddecoder Version 3.5 Sounddecoder Version 3.5 Décodeur version 3.5	121800	80

Symbolische Darstellung
Symbolic Illustration
Illustration figurative

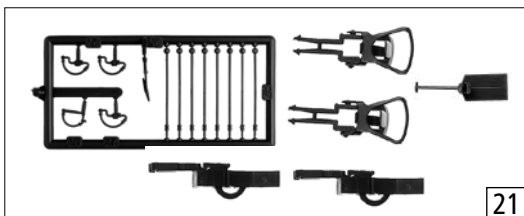
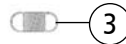
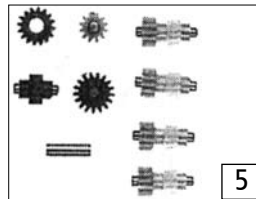
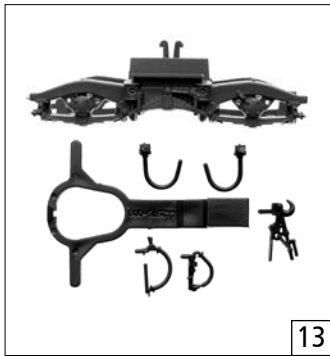
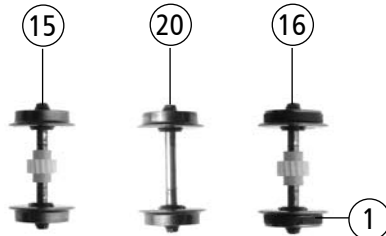
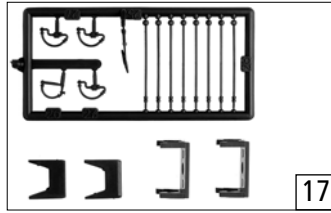
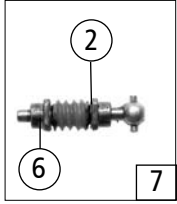

43083			X2800	=	
43084				=	
Pos. Nr. Pos.no. Position	Beschreibung Description Désignation	Art.-Nr. Art.no. Réf.	Preisgruppe Price-bracket Categorie de prix		
1	Hafrings.10Stk.8,3-10,2mm Set with traction tires Jeu de bandages d'adhérence	40068	--		
2	Beilagscheibe 2.1x4/0.2 mm Washer 2.1x4/.2 mm Rondelle	86102	2		
3	Zugfeder Spring Ressort de rappel	86208	2		
4	Zahnrad Z=16 rechts Gear Z=16 right Pignon Z=16 à droite	86435	2		
5	Getriebe Nachrüstsatz Gear expanding set Jeu d'engrenage complémentaire	86488	33		
6	Lager für Schneckenachse Worm axle bearing Cousinet	89749	6		
7	Schneckensatz kpl. Worm set Jeu de vis sans fin	115597	24		
8	Standardkupplung kpl. Coupling assembly Attelage	89246	5		
9	Radkontakt Wheel current contact strip Palpeurs	95827	2		
10	Kurzkupplung (Vorentkuppl.)kpl. Short coupling assembly Court Attelage	115550	5		
11	Teilesatz 1 f. Getriebe Parts set 1 gear Kit laquée 1 pour réducteur	115591	19		
12	Teiles. Getriebe Parts set gear Kit laquée réducteur	115592	10		
13	Teiles. Fahrwerk Parts set Undercarriage Kit laquée pour châssis	115606	10		
14	Teiles. 2 Getriebe Parts set 2 gear Kit laquée 2 pour réducteur	115609	21		
15	Radsatz ohne Hafring Wheelset without traction tires Essieu à roues sans bandagé	115610	18		
16	Radsatz mit 2 Hafring. Wheelset with 2 traction tires Essieu à roues avec bandagésohne	115611	20		
17	Teiles. Drehgestell Parts set bogie Essieu à roues bogie	115612	4		
18	Blende V. Triebw. Bogie frame V motor coach Diaphragme V pour motrice	115613	10		
19	Kontaktaltersatz Contact holder ser Kit laquée pour armature support	115614	3		
20	Radsatz ohne Hafring Wheelset without traction tires Essieu à roues sans bandagé	115615	18		
21	Zurüstbeutel Bag with accessories Sachet de pièces de finition	125893	18		

Ersatzteile erhalten Sie bei Ihrem Fachhändler, oder Ihrer Landesvertretung:
You can order your Replacement Parts at your local dealer, your country representative: